

UPS

UNINTERRUPTIBLE POWER SUPPLY

up to 4.8 MVA



GLOBAL SPECIALIST IN ELECTRICAL
AND DIGITAL BUILDING INFRASTRUCTURES



UPS systems: UPS units up to

SINGLE-PHASE UPS

Keor DC



Single-phase UPS DC 25W

[P. 14](#)

Keor Multiplug



Single-phase UPS line interactive VI from 0.6 to 0.8 kVA

[P. 15](#)

Keor SP



Single-phase UPS line interactive VI from 0.6 to 2 kVA

[P. 16](#)

Keor PDU



Single-phase UPS, off-line VFD 0.8 kVA

[P. 17](#)

MODULAR UPS

Megaline



Single-phase UPS, on-line double conversion VFI from 1.25 to 10 kVA

[P. 33](#)

Trimod HE



Three-phase UPS, on-line double conversion VFI from 10 to 80 kVA

[P. 37](#)

Trimod MCS



Modular CPS, on-line double conversion VFI from 3 to 80 kVA

[P. 40](#)

CONVENTIONAL UPS

Keor Compact



Three-phase UPS, on-line double conversion VFI from 10 to 20 kVA

[P. 48](#)

Keor T Evo



Three-phase UPS, on-line double conversion VFI from 10 to 60 kVA

[P. 50](#)

Keor HP



Three-phase UPS, on-line double conversion VFI from 100 to 800 kVA

[P. 52](#)

BATTERY CABINET



Universal battery cabinets for all three-phase UPS from 10 to 800 kVA.

[P. 58](#)

4.8 MVA

Niky S



Single-phase UPS line interactive VI-SS from 1 to 3 kVA

P. 18

Keor Line RT



Single-phase UPS line interactive VI-SS from 1 to 3 kVA

P. 19

Keor LP



Single-phase UPS, on-line double conversion VFI-SS-111 from 1 to 3 kVA

P. 20

Daker DK Plus



Single-phase UPS, on-line double conversion VFI from 1 to 10 kVA

P. 22

Keor S



Single-phase UPS, on-line double conversion VFI from 3 to 10 kVA

P. 26

Keor MOD



Three-phase UPS, on-line double conversion VFI from 25 to 250 kVA

P. 42

Keor HPE



Three-phase UPS, on-line double conversion VFI from 60 to 500 kVA

P. 54

Keor XPE



Three-phase UPS, on-line double conversion VFI from 600 to 2100 kVA

P.56

COMMUNICATION ACCESSORIES AND SOFTWARE

Network interfaces



P. 61

Network interface accessories



P. 62

Software



P. 63



UPS

High performance, uninterruptible service and energy efficiency.

The wide diffusion of UPS systems generally stems from an increasing dependence on electricity and the need to protect a range of equipment, data and processes that are crucial to companies. Power electronics is focused on the design and development of static UPS with increasing performance, which provide adequate energy saving along with lower environmental impact.

Safety and uninterruptible service

Any electronic device that is not properly protected by UPS systems may be subject to disturbances from the mains supply. Electrical events such as voltage dips, black-outs, voltage surges, or other voltage or frequency anomalies, can generate serious consequences including:

- interruption of services
- loss of data and information
- faults or damage to the actual electronic devices.

The solution to these problems is provided by Uninterruptible Power Supplies (UPS) which, when installed between the power supply network and the equipment, **improve the quality of the power** by ensuring **uninterruptible service** and **protection** of all devices that perform functions that are critical to the business life of companies.

Energy efficiency

Thanks to the use of the latest technologies, the new concept UPS boast high efficiency and an intelligent battery charging system that extends its useful life. In addition to significantly reducing UPS consumptions and operating costs, these features contribute to reducing the environmental impact of battery disposal.





LEGRAND IS A WORLD LEADER IN THE MANUFACTURING OF ELECTRICAL EQUIPMENT,

and offers a wide range of solutions for the tertiary sector, that meet all system demands, from cabling systems for data networks, to channelling and distribution systems, to plant control and management.

Today, with a view to technological development that respects the environment and in order to face a constantly evolving market, Legrand proposes a new UPS range, a complementary offer of technological functions able to guarantee maximum protection for all systems.

Legrand UPS is currently the manufacturer with the highest growth rate on the market; it also recently received two major awards worldwide and was named Company of the Year and Company with the highest growth rate by Frost & Sullivan (an international market research and consulting firm).

These results have been achieved through a number of factors such as recent acquisitions, product development activity and, above all, growth in sales of products and services.



SUSTAINABILITY

Corporate Social Responsibility

Green management and sustainable supply chain: these concepts are part of Legrand's Corporate Social Responsibility, which is the company's commitment to drawing up a strategy and implementing it with practical actions aimed at socially responsible behaviour towards everything around it, such as people, things and environment.

CSR involves the management of human resources, the organization and division of labour and the management of natural resources. CSR aims to assess the impact that the company's actions and decisions have internally, but also externally, on the stakeholders and the environment.

Circular economy

We are committed to creating a system that involves all stakeholders to share values, objectives and actions in order to control and reduce the environmental impact of all our economic and production processes, reduce waste and environmental impact and transform what would once have been defined as «waste» into new resources.

Controlling these aspects has an impact on the entire life cycle of the product, starting from the design of new concepts and new specifications for the materials the UPS is made of; this is possible through responsible design and procurement processes (so-called «green procurement»), with a strong focus on research and the use of innovative materials from the circular economy and alternative raw materials. When a product ends its life, all these materials can become high value-added resources that can be used in other production cycles.

Digitalization

New information technologies allow us to reduce the use of several paper documents in favor of the digital format: in this way the information is always and everywhere accessible from a PC or smartphone and at the same time we can avoid the felling of many trees.

Digitization also becomes an important driver of the circular economy, since it allows the use of tools for performance data analysis and preventive diagnostics, both useful for optimizing the life cycle and durability of the product.





BUSINESS ECOSYSTEM

or how Legrand interacts ethically with the whole ecosystem of its activities.

PEOPLE

or how Legrand engages with all of its employees and stakeholders.

ENVIRONMENT

or how Legrand intends to limit the Group's environmental impact.



Efficiency

Our R&D team is constantly working on the development of increasingly efficient UPSs that allow high and incremental performance with minimum energy dissipation; with regard to CO₂ emissions, we are implementing processes and products that represent an improvement in the percentage of carbon footprint compared to the past. But efficiency is not only synonymous with high performance. For us, efficiency also means ecodesign: this implies that the UPS is designed to be easily repaired, maintained and it's easy to separate its components. This means increasing the durability of our UPSs and the possibility of reusing and recycling them at the end of their life.

L'EPD/PEP

For each product range we draw up an EPD (Environmental Product Declaration) or PEP (Profil Environnemental Produit) in line with ISO 14025: it is a declaration that is a sort of environmental photograph of the product. The EPD is drawn up according to the concept of Life Cycle Assessment: it examines the environmental impact of a product throughout its life cycle, from the development of product specifications to the choice of materials to be used and the end-of-life destination of the product itself.





LEGRAND UPS

Distinguishing characteristics

High performance

The innovative design and high quality of the components used enable our UPS to achieve up to 96,5% efficiency, leading to significant energy savings.

Latest generation components

In-depth research on the best electronic components on the market combined with state-of-the-art manufacturing methods, make Legrand UPS extremely reliable and abreast of the times.

Environmentally sustainable products

Efficient UPS built with maximum attention to detail. Moreover, Legrand has developed an innovative testing system which reduces the energy consumed for each device manufactured.

Advanced technology

The On-line Double Conversion technology ensures a top quality power supply and maximum energy efficiency.

Reliable electronics

The optimum sizing of the power stages and thorough testing of each unit ensure excellent reliability.

High performance batteries

The batteries supplied with Legrand UPS are the best on the market. The innovative charging system significantly extends the life of the battery by up to 50%.

Services

Legrand provides a complete range of services to meet the demands of all its customers



Range of **application**

Each type of UPS is characterised by different design properties, which means that the range is ideally suitable and usable in different environments, from domestic to tertiary and industrial sectors, and applications in specific fields.

DOMESTIC APPLICATIONS

Video surveillance, home alarms, smart TV, Home Entertainment systems

TRADE AND TERTIARY SECTORS

Offices, shops, points of sale

HEALTH AND HOSPITALITY SECTORS

Hospitals, medical centres, hotels

INDUSTRIAL AND LARGE TERTIARY STRUCTURE SECTORS

Factories, warehouses, shopping centres

TRANSPORT

Airports, rail and ship transport

DATA PROCESSING CENTRES

Datacenter



RANGE

LEGRAND offers a range of UPS products that are divided into 2 different types of products: **single-phase and three-phase.**

The range is wide and complete, with solutions that guarantee maximum performance in terms of power and backup time.



Megaline -
Megaline Rack



Keor LP



Daker DK Plus



Keor S

Online

Single-phase UPS



Keor MOD



Trimod HE



Trimod MCS

Modular

Three-phase UPS



Keor Multiplug



Keor SP



Niky S



Keor Line RT



Keor PDU



Keor DC

Line Interactive



Off-line



DC



Keor Compact



Keor HP



Keor T Evo



Keor HPE



Keor XPE

Conventional



SINGLE-PHASE UPS

The **Legrand single-phase UPS range** is comprehensive and complete, with solutions that meet the demands of different application sectors, from domestic to tertiary.

The range is available from 25 W up to 10 kVA and is divided into 2 types of products:

- **Consumer and Line interactive**
- **On-Line double conversion**

Consumer and Line Interactive

These are compact UPS, easy to install and configure and provide an excellent high quality/price ratio together with the guarantee of a long-term investment.

They are equipped with LED indicators that provide monitoring of the UPS status, whilst guaranteeing protection of the devices connected to the same.

The Line Interactive products are equipped with a filtering and stabilizing circuit (AVR: Automatic Voltage Regulator).

This version comprises:

Keor DC - Keor Multiplug - Keor SP - Niky S - Keor Line RT - Keor PDU.

On-Line double conversion

These UPS use high frequency PWM technology, suitable for use in professional environments such as **IT application, offices, factories, shops and points of sale.**

They are fitted with:

- DSP microprocessors for precise, constant control of all measurements and of the power factor correction circuit (PFC)
- Transformer-free technology electronics for high quality energy output with up to 96% efficiency.
- Hermetically-sealed, maintenance-free, valve regulated rechargeable batteries, lodged inside a designated section of the UPS or in one or more external cabinets.

The products that are part of this version are:

Keor LP- Daker DK Plus - Keor S.



Keor LP

UPS for low and medium power applications, available with different types of output sockets. All versions have a slot for connecting SNMP communication interfaces.

THE ON-LINE RANGE



Keor LP
from 1 to 3 kVA



Keor DC

It provides power to all domestic Internet-connected devices such as modems, routers, cordless phones, or VoIP. Output voltage can be selected.

THE CONSUMER AND LINE INTERACTIVE RANGE



Keor DC
25 W



Keor Multiplug
from 600 to 800 VA

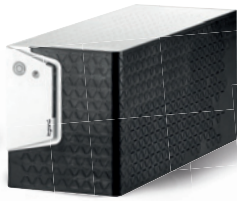

Keor SP
from 600 VA to 2 kVA



Niky S
from 1 to 3 kVA



Keor Line RT
from 1 to 3 kVA



Keor PDU
800 VA



Keor Multiplug - Keor SP - Niky S - Keor Line RT

These are line-interactive technology UPS that guarantee total and reliable protection for all Small-Office and Home-Office applications. They are supplied with electronic voltage regulator and telephone protection.



Keor PDU

It is specifically designed for installation in 19" panels and racks. IT is equipped with devices to protect against full battery discharge, overloads and short circuits.



Daker DK Plus

With the reversible screen, the Daker DK Plus UPS can be used in both tower and 19" rack configuration.



Daker DK Plus
from 1 to 10 kVA



Keor S

Compact, robust and easy to move, Keor S is the perfect UPS to protect and supply loads in the industrial fields. Two different models are available as internal configuration; internal battery only or input isolation transformer with internal battery. Protection Degree IP31



Keor S
from 3 to 10 kVA

Keor DC

Single-phase DC



3 100 11

UPS designed to provide the continuity of operation in case of power failure to all Internet connected devices such as modem, router, cordless or VoIP phones.

| Item | UPS | | |
|-----------------|-------------------|--------------------|----------------------|
| | Nominal power (W) | Back-up time (min) | Type of power socket |
| 3 110 10 | 25 | up to 90 | DE standard |
| 3 110 11 | | | IT standard |
| 3 110 12 | | | UK standard |
| 3 110 13 | | | US standard |

NOTE: the stated backup times in minutes are estimated and may vary according to the load characteristics, operating conditions and environment.

Characteristics

| General Characteristics | |
|----------------------------|---|
| Active power (W) | 25 |
| Input | |
| Input voltage | 100 / 240 VAC |
| Input frequency | 47-63 Hz |
| Input voltage range | 90 - 264 VAC |
| Output | |
| Output voltage | 9 - 12 - 15 - 19 Vdc selectable |
| Battery | |
| Type | Lithium-ion battery |
| Charge time (h) | 12 (90% of the capacity) |
| Nominal voltage | 3.7 Vdc |
| LED indicator | |
| Full battery | All green LEDs on |
| Battery discharging | Green LED, continuous blinking (2 s ON / 0.5 s OFF) |
| Low battery | Green LED, continuous blinking (0,3 s ON / OFF) |
| Fault | All green LEDs on, blinking (0,3 s ON/OFF) |
| Mechanical Characteristics | |
| Dimensions HxWxD (mm) | 95 x 95 x 28.5 |
| Net weight (g) | 300 |
| Conformity | |
| Certifications | EN55032, IEC/EN 62368-1, FCC: Class B, UL/cULus |

Power connectors

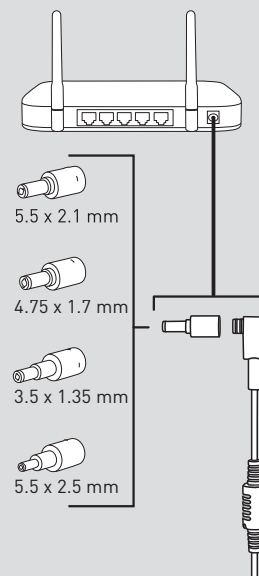

Keor Multiplug

Single-phase VI



3 100 82

Characteristics:

- Replaceable fuse in case of short-circuits
- LED indicators
- USB Charger
- Available outputs sockets in German or French type

| Item | UPS | | | | |
|-----------------|--------------------|------------------|--------------------|----------------|----------------------|
| | Nominal power (VA) | Active power (W) | Back-up time (min) | No. of sockets | Type of power socket |
| 3 100 81 | 600 | 360 | up to 15 | 4+2 | DE standard |
| 3 100 83 | 600 | 360 | | | FR standard |
| 3 100 82 | 800 | 480 | | | DE standard |
| 3 100 84 | 800 | 480 | | | FR standard |

NOTE: the stated backup times in minutes are estimated and may vary according to the load characteristics, operating conditions and environment.



Characteristics

| General Characteristics | 3 100 81 3 100 83 | 3 100 82 3 100 84 |
|---|------------------------------------|----------------------|
| Nominal power (VA) | 600 | 800 |
| Active power (W) | 360 | 480 |
| Technology | Line interactive VI | |
| Waveform | Simulated Sinewave | |
| Input | | |
| Input voltage | 230 V | |
| Input frequency | 50-60 Hz +/- 5Hz | |
| Input voltage range | 170 - 290 VAC | |
| Output | | |
| Output voltage | 230 V ± 10% | |
| Nominal output frequency | 50/60 Hz +/- 1 Hz | |
| USB Charger | USB type A (female) | |
| Mechanical Characteristics | | |
| Dimensions HxWxD (mm) | 190 x 89.5 x 296 | |
| Net weight (kg) | 5 | 5.5 |
| Ambient Conditions | | |
| Operating temperature (°C) | 0 – 40 | |
| Relative humidity (%) | < 95% non condensing | |
| Noise at 1 m (dBA) | < 40 | |
| Estimated content of circular economy derived materials | 24% | |
| Recyclability rate calculated using the method described in technical report IEC/TR 62635* | 42% | |
| Conformity | | |
| Certifications | EN 62040-1, EN 62040-2, EN 62040-3 | |

* The published value is based on data collected from an industrially organised technology supply chain and does not foresee the actual use by this supply chain of the electrical and electronic products at the end of their useful life.

Keor SP

Single-phase VI



3 101 83

3 101 92

Characteristics:

- 3-colour LED bar
- Mute Button (Silent)
- Internal AVR (automatic voltage regulator)
- USB Port
- Output sockets available for IEC, French or German standards

| Item | UPS with IEC output sockets | | | | |
|-----------------|-----------------------------|------------------|--------------------|--------------------|---------------------|
| | Nominal power (VA) | Active power (W) | Back-up time (min) | No. of sockets IEC | Communication ports |
| 3 101 80 | 600 | 360 | up to 15 | 4 | USB |
| 3 101 83 | 800 | 480 | up to 15 | 4 | USB |
| 3 101 86 | 1000 | 600 | up to 10 | 6 | USB |
| 3 101 89 | 1500 | 900 | up to 10 | 6 | USB |
| 3 101 92 | 2000 | 1200 | up to 10 | 6 | USB |

| Item | UPS with IEC output socket + German standard | | | | |
|-----------------|--|------------------|--------------------|------------------------------------|---------------------|
| | Nominal power (VA) | Active power (W) | Back-up time (min) | No. of sockets IEC+German standard | Communication ports |
| 3 101 81 | 600 | 360 | up to 15 | 1+1 | USB |
| 3 101 84 | 800 | 480 | up to 15 | 1+1 | USB |
| 3 101 87 | 1000 | 600 | up to 10 | 2+2 | USB |
| 3 101 90 | 1500 | 900 | up to 10 | 2+2 | USB |
| 3 101 93 | 2000 | 1200 | up to 10 | 2+2 | USB |

| Item | UPS with IEC+ French socket | | | | |
|-----------------|-----------------------------|------------------|--------------------|-----------------------|---------------------|
| | Nominal power (VA) | Active power (W) | Back-up time (min) | No. of sockets IEC+FR | Communication ports |
| 3 101 82 | 600 | 360 | up to 15 | 1+1 | USB |
| 3 101 85 | 800 | 480 | up to 15 | 1+1 | USB |
| 3 101 88 | 1000 | 600 | up to 10 | 2+2 | USB |
| 3 101 91 | 1500 | 900 | up to 10 | 2+2 | USB |
| 3 101 94 | 2000 | 1200 | up to 10 | 2+2 | USB |

Accessories

3 110 78 10A British Standard cable for all Keor SP

NOTE: the stated backup times in minutes are estimated and may vary according to the load characteristics, operating conditions and environment.



Characteristics

| General Characteristics | 3 101 80 | 3 101 83 | 3 101 86 | 3 101 89 | 3 101 92 |
|-------------------------|---------------------|----------|----------|----------|----------|
| | 3 101 81 | 3 101 84 | 3 101 87 | 3 101 90 | 3 101 93 |
| | 3 101 82 | 3 101 85 | 3 101 88 | 3 101 91 | 3 101 94 |
| Nominal power (VA) | 600 | 800 | 1000 | 1500 | 2000 |
| Active power (W) | 360 | 480 | 600 | 900 | 1200 |
| Technology | Line Interactive VI | | | | |
| Waveform | Simulated Sinewave | | | | |

| Input | |
|---------------------|------------------|
| Input voltage | 230 V ± 10% |
| Input frequency | 50-60 Hz +/- 5Hz |
| Input voltage range | 170 V-290 V |

| Output | |
|----------------------------|-----------------------|
| Output voltage | 230 V ± 10% |
| Output frequency (nominal) | 50/60 Hz +/-1Hz |
| USB Charger | - USB type A (female) |

| Communication and Management | |
|------------------------------|--|
| Screen and signalling | 2 buttons and LED bar to monitor UPS status in real-time |
| Remote control | available |

| Mechanical Characteristics | |
|----------------------------|---------------------------------------|
| Dimensions HxWxD (mm) | 120 x 138 x 330 148 x 173 x 380 |
| Net weight (kg) | 5 5.5 9 10.5 11.8 |

| Ambient Conditions | |
|----------------------------|----------------------|
| Operating temperature (°C) | 0 – 40 |
| Relative humidity (%) | < 95% non condensing |
| Noise at 1 m (dBA) | < 40 |

| | |
|---|------------|
| Estimated content of circular economy derived materials | 27% |
| Recyclability rate calculated using the method described in technical report IEC/TR 62635* | 43% |

| Conformity | |
|----------------|------------------------------------|
| Certifications | EN 62040-1, EN 62040-2, EN 62040-3 |

IEC sockets

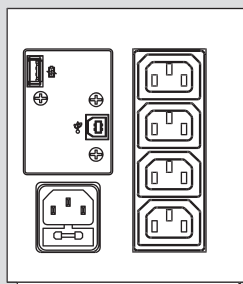

German standard sockets

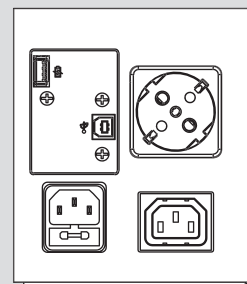

French socket

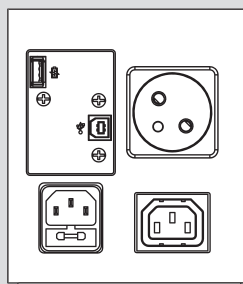

NOTES: The drawings refer to the Keor SP 800 version

* This value is based on data collected from a technological channel operating on an industrial basis. It does not pre-validate the effective use of this channel for end-of-life of this product.

Keor PDU

Single-phase VFD



3 103 32



3 110 18

Characteristics:

- Low energy consumption
- Economically advantageous solution
- More sockets with complete protection
- Front installation and maintenance
- Silent operations
- Less space occupied inside the cabinet
- Lower installation weight
- Ease of wiring and installation

| Item | UPS | | | | | |
|-----------------|--------------------|------------------|--------------------|----------------------|--------------------------------|---------------------|
| White | Nominal power (VA) | Active power (W) | Back-up time (min) | Type of power socket | Number - type of output socket | Communication ports |
| 3 103 30 | 800 | 480 | up to 15 | FR | 8 - FR | USB HID |
| 3 103 31 | | | | FR/DE/IT | 8 - IEC | |
| 3 103 32 | | | | FR/DE/IT | 8 - DE/IT | |
| 3 103 33 | | | | UK | 8 - IEC | |
| Black | 800 | 480 | up to 15 | FR | 8 - FR | USB HID |
| 3 110 16 | | | | FR/DE/IT | 8 - IEC | |
| 3 110 17 | | | | FR/DE/IT | 8 - DE/IT | |
| 3 110 18 | | | | FR/DE/IT | 8 - DE/IT | |
| 3 110 19 | | | | UK | 8 - IEC | |

NOTE: the stated backup times in minutes are estimated and may vary according to the load characteristics, operating conditions and environment.



Characteristics

| General Characteristics | |
|---|--|
| Nominal power (VA) | 800 |
| Active power (W) | 480 |
| Input | |
| Input voltage | 230 V |
| Input frequency | 45-65 Hz |
| Input voltage range | 180 - 270 VAC |
| Output | |
| Output voltage | 220/230/240 V a.c. ±10% |
| Nominal output frequency | 50/60 Hz ±1% |
| Power factor | 0.6 |
| Battery | |
| Type | VRLA - AGM without maintenance |
| Charge time (h) | 4-6 (90% capacity) |
| Communication and Management | |
| Remote control | Available |
| Screen and signalling | 3 LEDs to monitor UPS status in real-time |
| Protection | |
| Protection type | Protection against battery dying, overload and short circuit |
| Mechanical Characteristics | |
| Dimensions HxWxD (mm) | 88 x 440 x 150 |
| Net weight (kg) | 5.5 |
| Ambient Conditions | |
| Operating temperature (°C) | 0 – 40 |
| Relative humidity (%) | < 95% (non condensing) |
| Protection rating | IP20 |
| Noise at 1 m (dBA) | < 40 |
| Estimated content of circular economy derived materials | 37% |
| Recyclability rate calculated using the method described in technical report IEC/TR 62635* | 73% |
| Conformity | |
| Certifications | EN 62040-1, EN 62040-2, EN 62040-3 |

DE/IT standard sockets

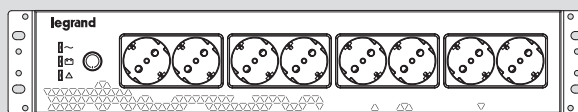

FR standard sockets

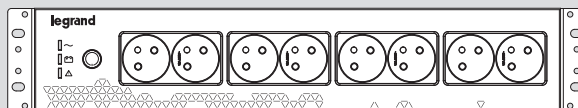

IEC standard sockets

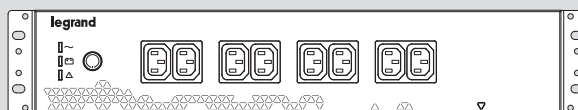

Rear sockets



*This value is based on data collected from a technological channel operating on an industrial basis. It does not pre-validate the effective use of this channel for end-of-life of this product.

For the choice of communication accessories, see the dedicated section of this catalogue.

Niky S

UPS Line Interactive - Single-phase VI-SS



3 100 06

Characteristics:

- Single-phase UPS
- Power from 1000 to 3000 VA
- Perfectly sinusoidal output waveform
- Line interactive VI
- AVR Converter Boost and Buck
- Microprocessor control
- Ease of battery replacement
- RS232 and USB communication ports
- LCD display
- Integrated self-diagnostic function
- Advanced battery discharge management
- Voltage peak protection and noise filter
- Power surge and short-circuit protection
- Internet Modem / LAN protection
- Cold start function
- Wiring fault indicator

| Item | UPS with IEC output sockets | | | | |
|-----------------|-----------------------------|------------------|---------------|--------------------|---------------------|
| | Nominal power (VA) | Active power (W) | Backup (min.) | No. of sockets IEC | Ports communication |
| 3 100 06 | 1000 | 600 | 5 | 6 | USB-RS232 |
| 3 100 20 | 1500 | 900 | 5 | 6 | USB-RS232 |
| 3 100 07 | 2000 | 1200 | 5 | 6 | USB-RS232 |
| 3 100 08 | 3000 | 1800 | 5 | 6 | USB-RS232 |

NOTE: the stated backup times in minutes are estimated and may vary according to the load characteristics, operating conditions and environment.



Characteristics

| General Characteristics | 3 100 06 | 3 100 20 | 3 100 07 | 3 100 08 |
|-------------------------|------------------------|----------|----------|----------|
| Nominal power (VA) | 1000 | 1500 | 2000 | 3000 |
| Active power (W) | 600 | 900 | 1200 | 1800 |
| Technology | Line interactive VI-SS | | | |
| Waveform | Sinusoidal | | | |

| Input | |
|---------------------|------------------|
| Input voltage | 230 V ± 10% |
| Input frequency | 50-60 Hz +/- 3Hz |
| Input voltage range | 160 - 290 VAC |

| Output | |
|--------------------------|-----------------------|
| Output voltage | 230V ± 10% |
| Nominal output frequency | 50/60 Hz +/-0.2% |
| THD of Output voltage | < 3% with linear load |

| Communication and Management | |
|------------------------------|--|
| Display and Signals | LCD display with three buttons and three LEDs to monitor UPS status in real-time |
| Telephone protection | RJ11/RJ45 |
| Remote control | Available |

| Mechanical Characteristics | | | |
|----------------------------|-------------|-------------|----|
| Dimensions HxWxD (mm) | 247x173x369 | 247x173x465 | |
| Net weight (kg) | 13 | 15 | 22 |

| Ambient Conditions | |
|----------------------------|-------------------------|
| Operating temperature (°C) | 0 – 40 |
| Relative humidity (%) | < 95 % (non condensing) |
| Noise at 1 m (dBA) | < 40 |

| | |
|---|------------|
| Estimated content of circular economy derived materials | 30% |
| Recyclability rate calculated using the method described in technical report IEC/TR 62635* | 66% |

| Conformity | |
|----------------|---------------------------------|
| Certifications | EN62040-1, EN62040-2, EN62040-3 |

| Warranty | |
|-------------------|-------------------------|
| Standard warranty | EXCHANGE 2 year formula |

1000-1500-2000 VA

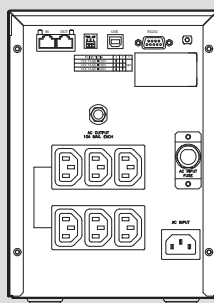

3000 VA

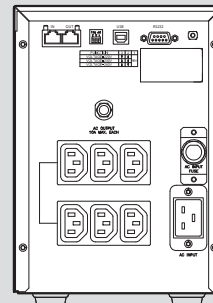

For the choice of communication accessories, see the dedicated section of this catalogue.

Download the free UPS management software at www.ups.legrand.com

* This value is based on data collected from a technological channel operating on an industrial basis. It does not pre-validate the effective use of this channel for end-of-life of this product.

Keor Line RT

Line Interactive UPS - Single phase VI-SS



3 100 45

Characteristics:

- Single-phase UPS reversible rack/tower
- Power from 1000 to 3000 VA
- Perfectly sinusoidal output waveform
- VI line-interactive
- Boost and Buck AVR converter
- Control by microprocessor
- The battery is easy to replace
- RS232 communication port
- LAN / SNMP connectivity
- LCD display
- Built-in self-test function
- Advanced management of battery discharge
- Protection from voltage peaks and noise filter
- Protection from overload and short-circuits
- Internet Modem / LAN protection
- Option of DC start-up
- USB-compatible

| Item | UPS with IEC socket | | | | |
|-----------------|---------------------|------------------|-------------------|------------------------------|---------------------|
| | Nominal power (VA) | Active power (W) | Backup time (min) | No. of sockets IEC (10A/16A) | Communication ports |
| 3 100 45 | 1000 | 900 | 10 | 8 / - | USB-RS232 |
| 3 100 46 | 1500 | 1350 | 8 | 8 / - | USB-RS232 |
| 3 100 47 | 2200 | 1980 | 8 | 8 / 1 | USB-RS232 |
| 3 100 48 | 3000 | 2700 | 8 | 8 / 1 | USB-RS232 |

Accessories

Description

- 3 109 69** Volt-free contact card
- 3 109 52** Rack support bracket kit

NOTE: the stated backup times in minutes are estimated and may vary according to the load characteristics, operating conditions and environment.

Characteristics

| General characteristics | 3 100 45 | 3 100 46 | 3 100 47 | 3 100 48 |
|-------------------------------------|--|----------|------------|----------|
| Nominal power (VA) | 1000 | 1500 | 2200 | 3000 |
| Active power (W) | 900 | 1350 | 1980 | 2700 |
| Technology | Line interactive VI-SS | | | |
| Waveform | Sinusoidal | | | |
| Input characteristics | | | | |
| Input voltage | 230 V ± 10 % | | | |
| Input frequency | 45-65 Hz | | | |
| Input voltage range | 165 V-300 V | | | |
| Output characteristics | | | | |
| Output voltage | 230 V ± 10 % | | | |
| Output frequency (nominal) | 50/60 Hz +/-0,5 % autosensing | | | |
| THD of output voltage | < 3 % with linear load | | | |
| Communication and management | | | | |
| Screen and signalling | Three buttons, display and three LEDs for real-time control of the status of the UPS | | | |
| Telephone protection | RJ11/RJ45 | | | |
| Remote control | SNMP Slot | | | |
| Mechanical characteristics | | | | |
| Dimensions W x D x H (mm) | 440x405x88 | | 440x650x88 | |
| Net weight (kg) | 19 | 20 | 34 | 37 |
| Ambient conditions | | | | |
| Ambient operating temperature (°C) | 0 - 40°C | | | |
| Relative humidity (%) | 0 - 95 % non-condensing | | | |
| Noise at 1 m (dBA) | < 40 | | | |
| Certifications | | | | |
| Reference product standards | EN62040-1, EN62040-2, EN62040-3 | | | |

1000-1500 VA

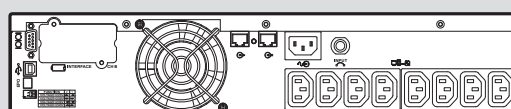

2200-3000 VA

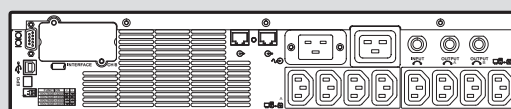

For the choice of communication accessories, see the dedicated section of this catalogue.

Keor LP

Conventional UPS - Single phase On-line double conversion VFI



3 101 54 3 101 56 3 101 58

Characteristics:

- Single-phase UPS
- Power from 1 to 3 kVA
- VFI-SS-111 on-line double conversion
- RS232 communication port
- LAN / SNMP connectivity
- Uptime can be extended with additional battery cabinets
- Compact design and low footprint

| Item | UPS with IEC sockets | | | | | |
|-----------------|----------------------|------------------|-------------------|------------------------|----------------------|-------------|
| | Nominal power (VA) | Active power (W) | Backup time (min) | No. of sockets IEC 10A | No. of french socket | Weight (kg) |
| 3 101 54 | 1000 | 900 | 5 | 3 | - | 10 |
| 3 101 56 | 2000 | 1800 | 5 | 6 | - | 17 |
| 3 101 58 | 3000 | 2700 | 5 | 6 | - | 23 |

| Item | UPS with french standard sockets | | | | | |
|-----------------|----------------------------------|------------------|-------------------|------------------------|----------------------|-------------|
| | Nominal power (VA) | Active power (W) | Backup time (min) | No. of sockets IEC 10A | No. of french socket | Weight (kg) |
| 3 101 55 | 1000 | 900 | 5 | 3 | 1 | 10 |
| 3 101 57 | 2000 | 1800 | 5 | 3 | 2 | 17 |
| 3 101 59 | 3000 | 2700 | 5 | 6 | 2 | 23 |

Accessories

Description

- 3 105 98*** Additional battery cabinet for 3 101 54 - 3 101 55
- 3 105 99*** Additional battery cabinet for 3 101 56 - 3 101 57
- 3 106 00*** Additional battery cabinet for 3 101 58 - 3 101 59
- 3 109 58** Additional battery charger for battery cabinet 3 105 98
- 3 109 60** Additional battery charger for battery cabinet 3 105 99
- 3 109 61** Additional battery charger for battery cabinet 3 106 00
- 3 109 53** Bypass
- 3 110 78** 10 A british standard cable for 3 101 54 - 3 101 55 - 3 101 56 - 3 101 57
- 3 110 79** 16 A british standard cable for 3 101 58 - 3 101 59

*Battery included

NOTE: the stated backup times in minutes are estimated and may vary according to the load characteristics, operating conditions and environment.

Keor LP 1000

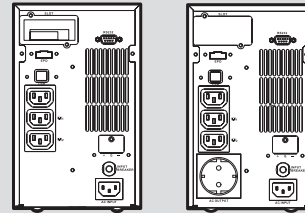

Keor LP 2000

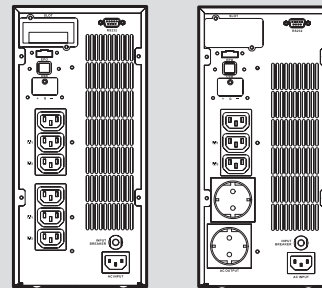

Keor LP 3000

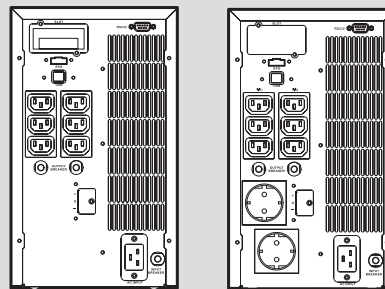

Keor LP

Conventional UPS - Single phase On-line double conversion VFI

| ■ Characteristics | | | |
|--|--|----------------------|----------------------|
| General characteristics | 3 101 54 3 101 55 | 3 101 56 3 101 57 | 3 101 58 3 101 59 |
| Nominal power (VA) | 1000 | 2000 | 3000 |
| Active power (W) | 900 | 1800 | 2700 |
| Technology | On-line double conversion VFI-SS-111 | | |
| Waveform | Sinusoidal | | |
| Architecture | UPS with extendable Backup time | | |
| Input characteristics | | | |
| Input voltage | 230 V | | |
| Input frequency | 45-65 Hz ±2 % Autosensing | | |
| Input voltage range | 210 V÷240 Vac at 100% load | | |
| Input power factor | > 0,99 | | |
| Output characteristics | | | |
| Output voltage | 230 V ± 1 % | | |
| Efficiency | Up to 90 % | | |
| Output frequency (nominal) | 50/60 Hz synchronised | | |
| Peak factor | 3 : 1 | | |
| THD of output voltage | < 3% with linear load | | |
| Overload capacity: | <105% ONLINE mode, 121÷150% for 10 sec., 106÷120% for 30 sec., >151% instant transfer to bypass | | |
| Bypass | Automatic, internal, synchronised, electromechanical (for overloads and operating problems) | | |
| Batteries | | | |
| Backup time extension | Si | | |
| Backup time (min) | 5 | | |
| Communication and management | | | |
| Screen and signalling | Multi-coloured LED status indicator, alarms and audible signalling | | |
| Communication ports | 1 RS232 serial port, 1 slot for network interface connection (ex. CS141) | | |
| Emergency Power Off (EPO) | Yes | | |
| Remote control | Software can be downloaded free of charge | | |
| Mechanical characteristics | | | |
| Dimensions (H x W x D) (mm) | 236 x 144 x 367 | 322 x 151 x 444 | 322 x 189 x 444 |
| Dimensions of battery cabinet (H x W x D) (mm) | 322 x 151 x 444 | 322 x 151 x 444 | 322 x 151 x 444 |
| Battery cabinet Net weight (kg) | 31 | 31 | 31 |
| Ambient conditions | | | |
| Ambient operating temperature (°C) | 0 - 40 | | |
| Relative humidity (%) | 20 - 80 non condensing | | |
| Noise at 1 m (dBA) | < 50 | | |
| Certifications | | | |
| Reference product standards | EN 62040-1, EN 62040-2, EN 62040-3 | | |

Daker DK Plus

Dual conversion online UPS (rack/tower) - single phase VFI



3 101 76



3 101 77



3 101 76 rack version

Characteristics:

- Conventional single-phase UPS
- Power from 1 to 10 kVA
- 0.9 power factor for 1000-3000, 1 for 5000-10000
- On-Line double conversion VFI-111
- User-friendly display
- Additional battery compartment to extend backup time
- Intelligent battery management
- Operator-friendly replaceable battery
- Display of battery status, system parameters, battery charge level and faults.

- Dedicated slot to connect one of the following two optional accessories: network interface (WEB/SNMP) or relay interface capable of providing isolated contacts for applications on industrial panels or remote alarm panels.
- Automatic bypass (and manual, optional) to guarantee uninterrupted power supply to critical loads, in the event of electronic failure, overload, overheating or scheduled maintenance.
- Maintenance bypass switch box (MTBS).

| Item | Convertible UPS with batteries | | | |
|-----------------|--------------------------------|------------------|-------------------|-------------|
| | Nominal power (VA) | Active power (W) | Backup time (min) | Weight (kg) |
| 3 101 70 | 1000 | 900 | 9 | 16 |
| 3 101 71 | 2000 | 1800 | 10 | 29,5 |
| 3 101 72 | 3000 | 2700 | 7 | 30 |
| 3 101 73 | 5000 | 5000 | 6 | 60 |
| 3 101 74 | 6000 | 6000 | 5 | 60 |

| Item | Convertible UPS without batteries | | | |
|------------------|-----------------------------------|------------------|---------------------|-------------|
| | Nominal power (VA) | Active power (W) | Phase configuration | Weight (kg) |
| 3 101 75 | 5000 | 5000 | 1/1 | 25 |
| 3 101 76 | 6000 | 6000 | 1/1 | 25 |
| 3 101 77 | 10000 | 10000 | 1/1 | 26 |
| 3 101 78* | 10000 | 9000 | 3/1 | 28 |

* three-phase input - single-phase output version

| Item | Battery cabinet with batteries |
|-----------------|---|
| 3 106 60 | Battery cabinet for 3 101 70 |
| 3 106 61 | Battery cabinet for 3 101 71 |
| 3 106 62 | Battery cabinet for 3 101 72 |
| 3 106 63 | Battery cabinet for 3 101 73 - 3 101 74 - 3 101 75 - 3 101 77 |
| 3 106 64 | Battery cabinet for 3 101 77 - 101 78 |

NOTE: the stated backup times in minutes are estimated and may vary according to the load characteristics, operating conditions and environment.



| Item | Empty battery cabinet |
|-----------------|---|
| 3 106 65 | Battery cabinet for 3 101 70 |
| 3 106 66 | Battery cabinet for 3 101 71 |
| 3 106 67 | Battery cabinet for 3 101 72 |
| 3 106 68 | Battery cabinet for 3 101 73 - 3 101 74 - 3 101 75 - 3 101 76 |
| 3 106 69 | Battery cabinet for 3 101 77 - 101 78 |

| Item | Accessories |
|-----------------|--|
| 3 109 52 | Rack support bracket kit |
| 3 109 53 | External manual bypass for 3 101 70 - 3 101 71 - 3 101 72 |
| 3 109 63 | External manual bypass for 3 101 73 - 3 101 74 - 3 101 75 - 3 101 76 - 3 101 77 |
| 3 109 69 | Dry contact card |
| 3 109 59 | Additional charger for 3 101 70 |
| 3 109 61 | Additional charger for 3 101 71 - 3 101 72 |
| 3 109 54 | Additional charger for 3 101 73 - 3 101 74 - 3 101 75 - 3 101 76 - 3 101 77 - 3 101 78 |
| 3 110 78 | 10 A british standard cable for 3 101 70 - 3 101 71 |
| 3 110 79 | 16 A british standard cable for 3 101 72 |

Daker DK Plus

UPS - double conversion online VFI

| Characteristics | | | | | | | | | |
|---|---|---------------------|-----------|------------------------------|---------------------|------------------|---------------------|------------------------------|-----------|
| General characteristics | 3 101 70 | 3 101 71 | 3 101 72 | 3 101 73 | 3 101 75 | 3 101 74 | 3 101 76 | 3 101 77 | 3 101 78 |
| Nominal power (VA) | 1000 | 2000 | 3000 | 5000 | | 6000 | | 10000 | 10000 |
| Active power (W) | 900 | 1800 | 2700 | 5000 | | 6000 | | 10000 | 9000 |
| Technology | On-Line Double Conversion VFI-SS-111 | | | | | | | | |
| Waveform | Sinusoidal | | | | | | | | |
| UPS Architecture | convertible tower and rack 19 | | | | | | | | |
| Input | | | | | | | | | |
| Input voltage | 230 V | | | | | | | | 380V 3F+N |
| Input frequency | 50-60 Hz \pm 5% Autosensing | | | | | | | | |
| Input voltage range | 180 - 300 Va.c. at full load | | | 170 - 280 Va.c. at full load | | | | 305 - 485 Va.c. at full load | |
| THD Input current | < 3% | | | | | | | | |
| Input power factor | > 0.99 | | | | | | | | > 0.9 |
| Output | | | | | | | | | |
| Output voltage | 230V \pm 1% | | | | | | | | |
| Nominal output frequency | 50/60 Hz (LCD screen settings) \pm 0,1% | | | | | | | | |
| Efficiency | Up to 90% | Up to 91% | Up to 92% | Up to 94% | | | | Up to 90% | |
| Crest factor | 3:1 | | | | | | | | |
| THD Output Voltage | < 3% with linear load | | | | | | | | |
| Output Voltage Tolerance | \pm 1% | | | | | | | | |
| Internal automatic bypass | Included | | | | | | | | |
| External maintenance bypass | optional | optional | optional | - | - | - | - | - | - |
| Batteries | | | | | | | | | |
| Backup time extension | Yes | | | | | | | | |
| Communication and Management | | | | | | | | | |
| Screen and signalling | LCD display with three buttons and five LEDs to monitor UPS status and main operating parameters in real time | | | | | | | | |
| Communication ports | RS232, USB | | | | | | | | RS232 |
| Remote control | Available | | | | | | | | |
| Network interface slot | Yes | | | | | | | | |
| Backfeed protection | Yes | | | | | | | | |
| Remote emergency power Off (EPO) | Yes | | | | | | | | |
| Mechanical Characteristics | | | | | | | | | |
| Dimensions HxWxD (mm) | 440 x 88 (2U) x 405 | 440 x 88 (2U) x 600 | | 440x196 (4U)x680 | 440x88 (2U)x680 | 440x196 (4U)x680 | 440x88 (2U)x680 | 440x132 (3U) x680 | |
| Net weight (kg) | 16 | 29.5 | 30 | 60 | 25 | 60 | 25 | 26 | 28 |
| Battery cabinet dimensions HxWxD (mm) | 440x196 (4U)x425 | 440 x 88 (2U) x 600 | | - | 440 x 88 (2U) x 680 | - | 440 x 88 (2U) x 680 | 440 x 132 (3U) x 680 | |
| Ambient Conditions | | | | | | | | | |
| Operating temperature (°C) | 0 – 40 | | | | | | | | |
| Protection rating | IP20 | | | | | | | | |
| Relative humidity (%) | < 95% (non condensing) | | | | | | | | |
| Noise at 1 m from the unit (dBA) | < 50 | | | | | | | | |
| Heat Dissipation (BTU/h) | 490 | 654 | 818 | 982 | 1300 | | 1636 | | |
| Estimated content of circular economy derived materials | 37% | | | | | | | | |
| Recyclability rate calculated using the method described in technical report IEC/TR 62635* | 74% | | | | | | | | |
| Conformity | | | | | | | | | |
| Certifications | EN 62040-1, EN 62040-2, EN 62040-3 | | | | | | | | |
| Warranty | | | | | | | | | |
| Standard warranty | EXCHANGE 2 year formula | | | | | | | | |

NOTE: The stated backup times in minutes are estimated and may vary according to the load characteristics, operating conditions and environment

*This value is based on data collected from a technological channel operating on an industrial basis. It does not pre-validate the effective use of this channel for end-of-life of this product.

Daker DK Plus

UPS - On-line double conversion VFI, 120V



3 101 40

Convertible 120V UPS with batteries (UL)

| Item | Nominal power (VA) | Active power (W) | Backup time (min) | Weight (kg) |
|-----------------|--------------------|------------------|-------------------|-------------|
| 3 101 40 | 1000 | 900 | up to 15 | 11 |
| 3 101 41 | 1500 | 1350 | up to 15 | 14,5 |
| 3 101 42 | 2000 | 1800 | up to 15 | 20 |
| 3 101 43 | 3000 | 2700 | up to 15 | 27 |

Battery cabinet with batteries (UL)

Description

| | |
|-----------------|-----------------------------------|
| 3 101 44 | Battery cabinet for 3 101 40 (UL) |
| 3 101 45 | Battery cabinet for 3 101 41 (UL) |
| 3 101 46 | Battery cabinet for 3 101 42 (UL) |
| 3 101 47 | Battery cabinet for 3 101 43 (UL) |

Accessories

Description

| | |
|-----------------|--------------------------|
| 3 109 52 | Rack support bracket kit |
| 3 109 69 | Dry contact card |

NOTE: the stated backup times in minutes are estimated and may vary according to the load characteristics, operating conditions and environment.

Characteristics

| General characteristics | 3 101 40 | 3 101 41 | 3 101 42 | 3 101 43 |
|--|--|---------------------|-------------------------------|----------|
| Nominal power (VA) | 1000 | 1500 | 2000 | 3000 |
| Active power (W) | 900 | 1350 | 1800 | 2700 |
| Technology | On-line double conversion VFI-SS-111 | | | |
| Waveform | Sinusoidal | | | |
| Architecture | Convertible tower and 19" rack | | | |
| Input characteristics | | | | |
| Input voltage | 120 V | | | |
| Input frequency | 50-60 Hz \pm 5% autosensing | | | |
| Input voltage range | 90V - 150V at full load | | | |
| THD of input current | < 3% | | | |
| Input power factor | > 0,99 | | | |
| Input connection | NEMA 5-15P | NEMA 5-20P | NEMA L5-30P | |
| Output characteristics | | | | |
| Output voltage | 120 V \pm 1%, adjustable to 100/110/115/120 | | | |
| Output frequency (nominal) | 50/60 Hz (configurable via LCD panel) \pm 0.1% | | | |
| Efficiency | up to 92% | | | |
| Peak factor | 3:1 | | | |
| THD of output voltage | < 3% with linear load | | | |
| Output voltage tolerance | \pm 1% | | | |
| Output Connection | 6*NEMA 5-15R | 6*NEMA 5-20P | 6*NEMA 5-20P 1*NEMA L5-30P | |
| Internal automatic bypass | included | | | |
| Batteries | | | | |
| Backup time extension | Yes | | | |
| Battery nominal voltage (Vdc) | 24 | 36 | 48 | 72 |
| Communication and management | | | | |
| Screen and signalling | Four buttons and five LEDs for real-time control | | | |
| Communication ports | RS232 and USB serial ports | | | |
| Remote control | Available | | | |
| Connector for network interface | SNMP | | | |
| Back feed protection | yes | | | |
| Emergency power off (EPO) | yes | | | |
| Mechanical characteristics | | | | |
| Dimensions (H x W x D) (mm) | 440 x 88 (2U) x 405 | 440 x 88 (2U) x 485 | 440 x 88 (2U) x 600 | |
| Net weight (kg) | 11 | 14.5 | 20 | 27 |
| Dimensions of battery cabinet H x W x D (mm) | 40 x 88 (2U) x 600 | | | |
| Ambient conditions | | | | |
| Operating temperature (°C) | 0 - 40°C | | | |
| Protection index | IP 20 | | | |
| Relative humidity (%) | 0-90% (without condensation) | | | |
| Noise at 1 m (dBA) | < 50 | | | |
| Certifications | | | | |
| Reference product standards | UL1778 V4 (cTUVus), FCC Part 15 Class A | | | |

Daker DK Plus

Long backup times table

| Model | Power | Back-up time | No. cabinets and dimensions HxWxD (mm) | Codes |
|---------------------|----------|--|--|--------------------------|
| Daker DK Plus | 1000 VA | 9' | 440 x 88 x 405 | 3 101 70 |
| | | 1h 27' | 440 x 88 x 405 + 440 x 196 x 425 | 3 101 70 + 3 106 60 |
| | | 3h | 440 x 88 x 405 + 440 x 196 x 425 (x2) | 3 101 70 + 3 106 60 (x2) |
| | 2000 VA | 10' | 440 x 88 x 600 | 3 101 71 |
| | | 45' | 440 x 88 x 600 (x2) | 3 101 71 + 3 106 61 |
| | | 1h 28' | 440 x 88 x 600 (x3) | 3 101 71 + 3 106 61 (x2) |
| | 3000 VA | 7' | 440 x 88 x 600 | 3 101 72 |
| | | 31' | 440 x 88 x 600 (x2) | 3 101 72 + 3 106 62 |
| | | 58' | 440 x 88 x 600 (x3) | 3 101 72 + 3 106 62 (x2) |
| | | 1h 29' | 440 x 88 x 600 (x4) | 3 101 72 + 3 106 62 (x3) |
| | 5000 VA | 6' | 440 x 88 x 680 + 440 x 88 x 680 | 3 101 75 + 3 106 63 |
| | | 19' | 440 x 88 x 680 + 440 x 88 x 680 (x2) | 3 101 75 + 3 106 63 (x2) |
| | | 32' | 440 x 88 x 680 + 440 x 88 x 680 (x3) | 3 101 75 + 3 106 63 (x3) |
| | | 50' | 440 x 88 x 680 + 440 x 88 x 680 (x4) | 3 101 75 + 3 106 63 (x4) |
| | 6000 VA | 5' | 440 x 88 x 680 + 440 x 88 x 680 | 3 101 76 + 3 106 63 |
| | | 15' | 440 x 88 x 680 + 440 x 88 x 680 (x2) | 3 101 76 + 3 106 63 (x2) |
| | | 30' | 440 x 88 x 680 + 440 x 88 x 680 (x3) | 3 101 76 + 3 106 63 (x3) |
| | | 45' | 440 x 88 x 680 + 440 x 88 x 680 (x4) | 3 101 76 + 3 106 63 (x4) |
| 10000 VA | 6' | 440 x 132 x 680 + 440 x 132 x 680 | 3 101 77 + 3 106 64 | |
| | 17' | 440 x 132 x 680 + 440 x 132 x 680 (x2) | 3 101 77 + 3 106 64 (x2) | |
| | 28' | 440 x 132 x 680 + 440 x 132 x 680 (x3) | 3 101 77 + 3 106 64 (x3) | |
| | 41' | 440 x 132 x 680 + 440 x 132 x 680 (x4) | 3 101 77 + 3 106 64 (x4) | |
| | 54' | 440 x 132 x 680 + 440 x 132 x 680 (x5) | 3 101 77 + 3 106 64 (x5) | |
| Daker DK plus 3 - 1 | 10000 VA | 7' | 440 x 132 x 680 + 440 x 132 x 680 | 3 101 78 + 3 106 64 |
| | | 19' | 440 x 132 x 680 + 440 x 132 x 680 (x2) | 3 101 78 + 3 106 64 (x2) |
| | | 31' | 440 x 132 x 680 + 440 x 132 x 680 (x3) | 3 101 78 + 3 106 64 (x3) |
| | | 45' | 440 x 132 x 680 + 440 x 132 x 680 (x4) | 3 101 78 + 3 106 64 (x4) |
| | | 59' | 440 x 132 x 680 + 440 x 132 x 680 (x5) | 3 101 78 + 3 106 64 (x5) |

NOTE: the stated backup times in minutes are estimated and may vary according to the load characteristics, operating conditions and environment.

Configuration

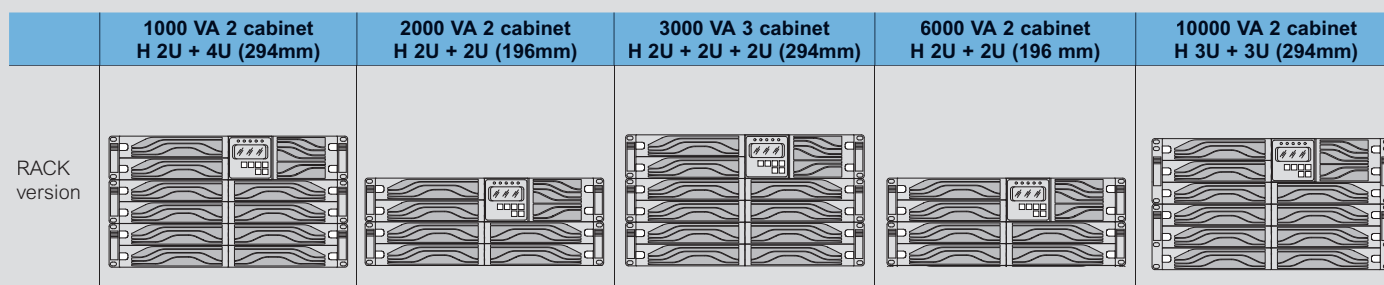
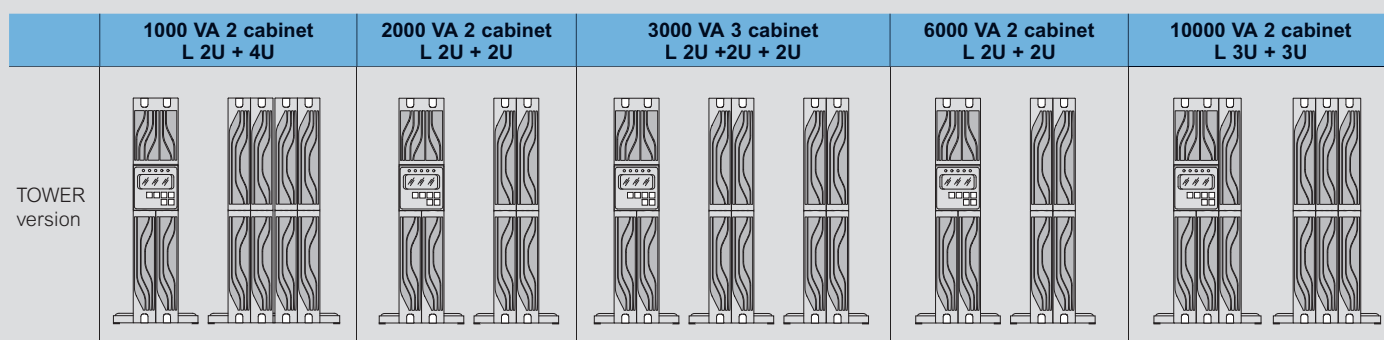

Keor S

Conventional UPS - Single-phase On-line double conversion



3 101 21

3 107 41

Characteristics:

- 3kVA to 10 KVA Capacity Range
- 1 Phase Input / 1 Phase Output
- IGBT Inverter - IGBT Rectifier
- High Efficiency
- Digital Signal Processor (DSP)
- High Input Power Factor (PFC)
- High Output Power Factor
- Low Input and Output Total Harmonic Distortion (THD)
- Generator Compatible Operation
- Standard IP31 Protection for Industrial Applications
- On Site Modular Paralleling Capability up to 4 Units (except 3kVA)
- Additional External Chargers for Long Back-Up Time Solutions (6-10kVA only)
- Availability of Different Communication Types
- User friendly diagnostic
- Advanced management and communication
- Integrated By-pass for maintenance
- LCD display with interactive menu

| Item | Single-phase UPS | | | |
|-----------------|--------------------|------------------|-------------------|-----------------|
| | Nominal power (VA) | Active power (W) | Backup time (min) | Net weight (kg) |
| 3 101 21 | 3000 | 2400 | 10 | 53 |
| 3 101 22 | 3000 | 2400 | 27 | 75 |
| 3 101 23 | 3000 | 2400 | 50 | 97 |
| 3 101 28 | 6000 | 5400 | 22 | 106 |
| 3 101 31 | 10000 | 9000 | 10 | 114 |

| Item | Single-phase UPS with isolation transformer | | | |
|-----------------|---|------------------|-------------------|-----------------|
| | Nominal power (VA) | Active power (W) | Backup time (min) | Net weight (kg) |
| 3 101 25 | 3000 | 2400 | 10 | 85 |
| 3 101 29 | 6000 | 5400 | 0 | 100 |
| 3 101 35 | 10000 | 9000 | 0 | 126 |

Battery cabinet

Description

- 3 107 40** Empty battery cabinet
- 3 107 41** Battery cabinet (for KEOR S 3000)
- 3 107 42** Battery cabinet (for KEOR S 3000)
- 3 107 43** Battery cabinet (for KEOR S 3000)
- 3 107 44** Battery cabinet (for KEOR S 6000-10000)
- 3 107 45** Battery cabinet (for KEOR S 6000-10000)

Accessories

Description

- 3 109 61** Battery charger for additional battery cabinet (for 3 107 41 - 3 107 42 - 3 107 43)
- 3 109 54** Battery charger for additional battery cabinet (for 3 107 44 - 3 107 45)

NOTE: The stated Backup times in minutes are estimated and may vary according to the load characteristics, operating conditions and environment.

For the choice of communication accessories, see the dedicated section of this catalogue.

- UPS with internal batteries Backup time up to 50 min for 3 kVA

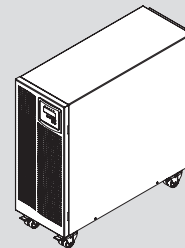

- UPS for long Backup time with additional battery cabinet

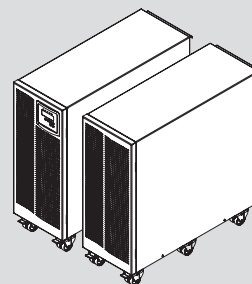

- UPS with isolation transformer built in

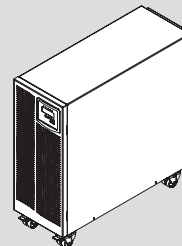

- Rear pannel



- Long Backup time table

| Power | UPS | Battery cabinet | Backup time (min.) |
|-------|----------|-----------------|--------------------|
| 6000 | 3 101 28 | 3 107 44 | 55 |
| 6000 | 3 101 28 | 3 107 45 | 85 |
| 10000 | 3 101 31 | 3 107 44 | 27 |
| 10000 | 3 101 31 | 3 107 45 | 50 |
| 6000 | 3 101 29 | 3 107 45 | 55 |
| 6000 | 3 101 29 | 3 107 44 | 22 |
| 10000 | 3 101 35 | 3 107 44 | 10 |
| 10000 | 3 101 35 | 3 107 45 | 27 |

Keor S

Conventional UPS - Single-phase On-line double conversion

| ■ Characteristics | | | |
|---|---|---|--------|
| General characteristics | 3 kVA | 6 kVA | 10 kVA |
| Nominal power (VA) | 3000 | 6000 | 10000 |
| Active power (W) | 2400 | 5400 | 9000 |
| Technology | On-line double conversion | | |
| Waveform | Sinusoidal | | |
| Architecture | conventional UPS | | |
| Input characteristics | | | |
| Input voltage | 220V-230V-240V | | |
| Input frequency | 45-65 Hz | | |
| Input voltage range | 160V-288V | 195V-280 V | |
| THD of input current | 6% | | |
| Input power factor | > 0,99 | | |
| Output characteristics | | | |
| Output voltage | 220V/230V/240V Adjustable from Front Panel | | |
| Output frequency (nominal) | 50 /60 Hz Adjustable from Front Panel +/- 0,05% | | |
| Crest factor | 2,5:1 | | |
| THD of output voltage | < 1,5% with linear load < 3% with non-linear load | | |
| Overload capacity | 10 seconds at 125%-150% 30 seconds at 106%-120% | 120 seconds at 100%-120% 30 seconds at 121%-150% | |
| Efficiency in Eco mode | 98% | | |
| Bypass | - | Automatic bypass and manual maintenance bypass | |
| Batteries | | | |
| Backup time extension | Yes | | |
| Communication and management | | | |
| LCD Display | Available | | |
| Communication Port | 1 RS232 serial ports, 1 USB port, modbus and SNMP optional | 1 RS232 serial ports, modbus and SNMP optional | |
| Remote Management | Available | | |
| Mechanical characteristics | | | |
| Dimensions H x W x D (mm) | 716 x 275 x 776 | | |
| Dimensions battery cabinet H x W x D (mm) | 716 x 275 x 776 | | |
| Ambient conditions | | | |
| Operating temperature (°C) | 0 - 40 | | |
| Relative humidity (%) | <95% (non condensing) | | |
| Protection index | IP31 | | |
| Noise at 1 m (dBA) | < 50 | | |
| Compliance | | | |
| Reference product standards | EN 62040-1, EN 62040-2, EN 62040-3 | | |

MODULAR UPS

Its continuous research combined with modern production methods has allowed **Legrand to launch state-of-the-art modular UPS units on the market**, with top ranking performances: efficiency certified up to 96,5% and unit power factor.

Thanks to the high-performance components and space-efficient structures, these products are the ideal solution for advanced energy management and cost containment.

The Legrand modular UPS units are high frequency PWM uninterruptible power supplies, On Line type with Double Conversion, modular architecture, and redundant N+X configuration option.

They can be sized to meet the customer's needs, without precluding any future implementations.

The products that are part of this version are:

**Megaline - Trimod HE -
Trimod MCS - Keor MOD**

HIGH performances
HIGH efficiency
RESPECT of the environment



Megaline
Megaline Rack
from 1.25 to 10 kVA

Trimod HE
from 10 to 80 kVA

Keor MOD
from 25 to 250 kVA

CERTIFIED EFFICIENCY

The Legrand modular UPS guarantee exceptionally high efficiency values, up to 4% higher than the minimum values required by the European Code of Conduct (92%).

96,5%

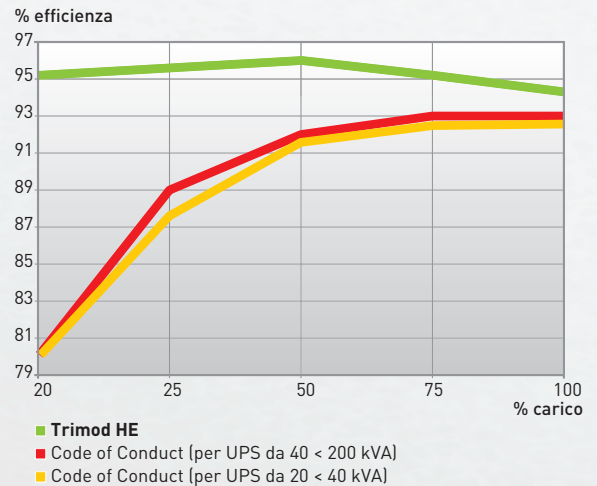

Increase in stand-by time and power

The different models are composed by STANDARD modules that can be added to existing UPS units to extend both power and backup time and guarantee maximum levels of redundancy.

Scalability of backup times

The expansion can be performed quickly and easily by adding battery drawers to the same cabinet, depending on the power of the UPS and the backup time requirements.



Single drawer with 5 9Ah batteries for Trimod HE and Trimod MCS.



Battery drawer for Keor MOD, designed to contain up to 24 9 or 11 Ah batteries.

Power and redundancy modules

The power modules are available in both single-phase and three-phase versions, depending on the power of the UPS. Both models guarantee low weight and overall dimensions along with top ranking performance. Thanks to the construction technology the various redundancy levels can be set to always guarantee maximum service continuity.



Single phase power module for Trimod HE and Trimod MCS. Compact and lightweight (only 8.5 kg)



Three-phase power module for Keor MOD. Reaches a power output of 25 kW with just 2 rack units required

MODULAR UPS

High redundancy levels

Redundancy on single phase load

In a three-phase power supply system with single phase loads, if one of the modules fails, there is no loss of power as the power is distributed over the other modules that are still operational.

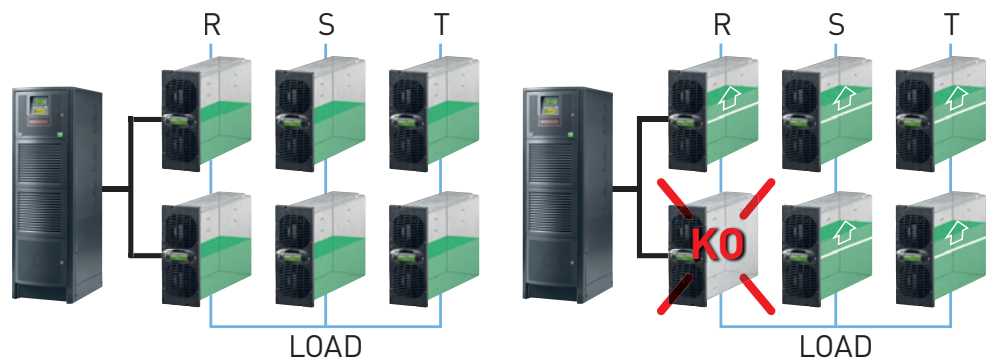

Phase redundancy

In a system with three-phase outputs, it is possible to create redundancy on each individual phase. If one of the power modules fails, the other modules for this phase take over from the faulty module.

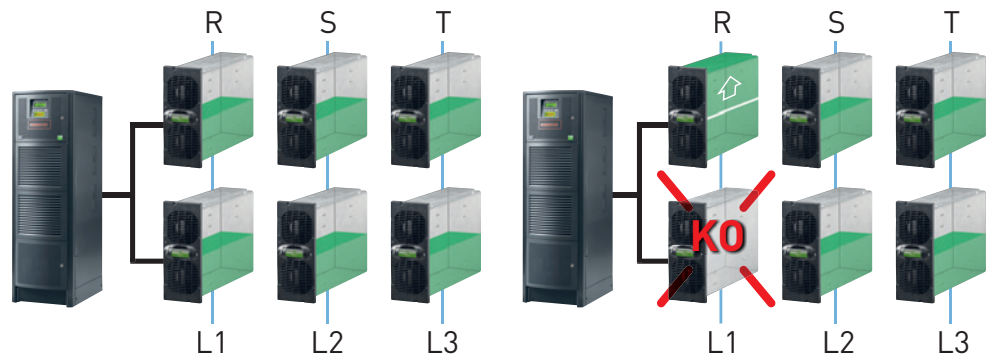

Control module redundancy

In UPS that include several control modules, the failure of one of the control modules results in the modules it controls being stopped. However continuity of service is assured by the automatic distribution of the lost power over the other modules.

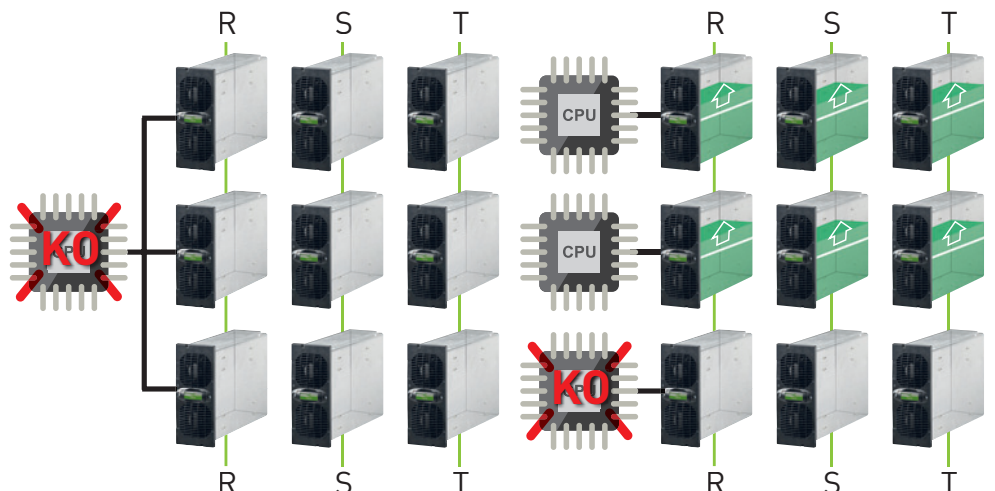

EXCLUSIVE ROTATING TOUCH SCREEN DISPLAY

The Keor MOD has a 10" touch screen display provides a simplified control panel packed with information, alerts and settings and is also equipped with interactive icons to make navigation and selection of the functions to be controlled quick and simple. The possibility of being able to rotate the Display inwards by 180° simplifies and speeds up the configuration and maintenance phases.

The display is positioned vertically so you have both the operating block diagram and the UPS layout with all the available information all on the same screen.



Decentralised bypass system

The decentralised bypass architecture reduces repair and maintenance time and costs. Each power module contains an independent bypass that, in the event of a failure, allows the remaining modules to simply to bypass mode, ensuring full functionality. The complete independence of the modules makes it possible to perform all maintenance and expansion phases in an extremely swift and simple way.



Attention to design

The elegance of the design and the skilful choice of materials give the Legrand UPS units a sleek and cutting-edge look.



MODULAR UPS



Trimod HE

It consists of individual redundant and self-configuring single phase modules and has a nominal power rating of 10 to 80 kVA. Thanks to the construction technology the various redundancy levels can be set to always guarantee maximum service continuity.



Megaline and Megaline Rack

These are the only single-phase UPS units in the modular range. The single cabinet and 19" rack deliver a power of 1250 to 5000 VA and can house a maximum of 4 power modules and 4 battery kits. The range also includes double cabinets with a nominal power of up to 10000 VA. Further batteries can be housed in specific cabinets, and are easy to connect thanks to the backup extension fittings.

There are 3 versions available:

- SINGLE CABINET
- DOUBLE CABINET
- 19" RACK CABINET



Keor MOD

It is an uninterruptible power supply based on three phase power modules, extremely compact and easy to handle. It delivers a nominal power from 25 to 250 kVA, it can be connected in parallel with other units up to 600 kVA.

Models up to 125 kVA have internal batteries for 5 minute backup time at 100% load.

Keor MOD integrates perfectly with the most critical applications such as Data Centers.

Trimod MCS

The Trimod MCS CPS (Central Power Supply) is a single phase and three-phase centralised power supply system designed according to EN 50171 standards and represents the ideal solution for installation in buildings subject to fire safety standards and, specifically, to power emergency lighting systems. It can also be used to power emergency systems such as automatic fire extinguishing systems, emergency detection and alarm systems, smoke exhaust and carbon dioxide detection devices and specific safety systems in sensitive areas.



Megaline

Modular single-phase double conversion UPS VFI



3 103 60 + 3 107 78



3 108 77



3 107 85



3 108 35

Characteristics:

- Modular single-phase UPS
- Power from 1250 to 10000 VA
- On-Line double conversion VFI-111
- Adaptable, expandable and redundant solutions in a single cabinet
- Swift and simple maintenance and management
- Low environmental impact (high efficiency and reduced footprint)
- Single or double cabinet UPS unit depending on the output power
- Wide range of input voltage and frequency ranges
- Operating frequency of 50 - 60 Hz with self-recognition mode
- Frequency converter 50 in - 60 out or vice versa
- Extension of the input frequency rate for operations with genset units
- Eco Mode operations (energy saving)
- Load waiting mode operations (protection on demand)
- Output voltage adjustable in 1 volt steps from the front control panel
- Very low noise level
- Internal and external temperature reader
- Controls ventilation depending on the temperature and load
- Emergency remote shutdown option

| Item | Single cabinet (German standard) | | | | |
|-----------------|----------------------------------|------------------|---------------------|-------------|-------------|
| | Nominal power (VA) | Active power (W) | Back-up time (min.) | No. Cabinet | Weight (kg) |
| 3 103 50 | 1250 | 875 | 13 | 1 | 23.5 |
| 3 103 52 | 2500 | 1750 | 13 | 1 | 34 |
| 3 103 54 | 3750 | 2625 | 13 | 1 | 43 |
| 3 103 56 | 5000 | 3500 | 13 | 1 | 53 |

| Item | Double Cabinet | | | | |
|----------------------------|--------------------|------------------|---------------------|-------------|-------------|
| | Nominal power (VA) | Active power (W) | Back-up time (min.) | No. Cabinet | Weight (kg) |
| 3 103 60 + 3 107 78 | 5000 | 3500 | 13 | 2 | 24+50 |
| 3 103 63 + 3 107 79 | 6250 | 4375 | 13 | 2 | 27+58 |
| 3 103 66 + 3 107 80 | 7500 | 5250 | 13 | 2 | 29+65 |
| 3 103 69 + 3 107 81 | 8750 | 6125 | 13 | 2 | 32+73 |
| 3 103 72 + 3 107 82 | 10000 | 7000 | 13 | 2 | 34+80 |

| Item | Single cabinet (French standard) | | | | |
|-----------------|----------------------------------|------------------|---------------------|--------------------|-------------|
| | Nominal power (VA) | Active power (W) | Back-up time (min.) | Number of cabinets | Weight (kg) |
| 3 103 42 | 1250 | 875 | 13 | 1 | 23.5 |
| 3 103 43 | 2500 | 1750 | 13 | 1 | 34 |
| 3 103 44 | 3750 | 2625 | 13 | 1 | 43 |
| 3 103 45 | 5000 | 3500 | 13 | 1 | 53 |

NOTE: the stated backup times in minutes are estimated and may vary according to the load characteristics, operating conditions and environment.

| Item | Single cabinet - without batteries | | | |
|-----------------|------------------------------------|------------------|---------------------|--------------------|
| | Nominal power (VA) | Active power (W) | Back-up time (min.) | Number of cabinets |
| 3 103 51 | 1250 | 875 | 13 | 1 |
| 3 103 53 | 2500 | 1750 | 13 | 1 |
| 3 103 55 | 3750 | 2625 | 13 | 1 |
| 3 103 57 | 5000 | 3500 | 13 | 1 |

| Item | Double cabinet - without batteries | | | |
|----------------------------|------------------------------------|------------------|---------------------|--------------------|
| | Nominal power (VA) | Active power (W) | Back-up time (min.) | Number of cabinets |
| 3 103 60 + 3 108 59 | 5000 | 3500 | - | 2 |
| 3 103 63 + 3 108 59 | 6250 | 4375 | - | 2 |
| 3 103 66 + 3 108 59 | 7500 | 5250 | - | 2 |
| 3 103 69 + 3 108 59 | 8750 | 6125 | - | 2 |
| 3 103 72 + 3 108 59 | 10000 | 7000 | - | 2 |

| Item | with charger | | Battery extensions | |
|-----------------|-----------------|--------------------|--------------------|--|
| 3 107 75 | 3 107 86 | Cabinet with 1 bk | | |
| 3 107 76 | 3 107 87 | Cabinet with 2 bk | | |
| 3 107 77 | 3 107 88 | Cabinet with 3 bk | | |
| 3 107 78 | 3 107 89 | Cabinet with 4 bk | | |
| 3 107 79 | 3 107 90 | Cabinet with 5 bk | | |
| 3 107 80 | 3 107 91 | Cabinet with 6 bk | | |
| 3 107 81 | 3 107 92 | Cabinet with 7 bk | | |
| 3 107 82 | 3 107 93 | Cabinet with 8 bk | | |
| 3 107 83 | 3 107 94 | Cabinet with 9 bk | | |
| 3 107 84 | 3 107 95 | Cabinet with 10 bk | | |

| Item | Accessories |
|-----------------|---|
| 3 108 35 | Power module (PW 1250) |
| 3 108 57 | Single cabinet backup extension (bk Megaline/1) |
| 3 108 58 | Double cabinet backup extension (bk Megaline/2) |
| 3 108 59 | Empty battery cabinet |
| 3 108 60 | Y cable for connecting a second additional battery cabinets (check the long life tables for the number of cables) |
| 3 108 61 | Battery cabinet extension kit for tower configuration (Megaline PL cable) |
| 3 108 77 | Manual bypass for single cabinet (BP/1) |
| 3 108 78 | Manual bypass for double cabinet (BP/2) |
| 3 107 85 | Additional battery charger (CB 36) |
| 3 109 72 | Relay interface kit |

For the choice of communication accessories, see the dedicated section of this catalogue.

bk: battery kit

Megaline Rack

Modular single-phase double conversion UPS VFI



3 103 85



3 107 96



3 108 77



3 107 85



3 109 73

Characteristics:

- Modular single-phase UPS
- Output from 1250 to 5000 VA
- Wide range of input voltage and frequency ranges
- Operating frequency of 50 - 60 Hz with self-recognition mode
- Frequency converter 50 in - 60 out or vice versa
- Extension of the input frequency rate for operations with genset units
- Eco Mode operations (energy saving)
- Load waiting mode operations (protection on demand)
- Output voltage adjustable in 1 volt steps from the front control panel
- Very low noise level
- Internal and external temperature reader
- Controls ventilation depending on the temperature and load
- Emergency remote shutdown option

| Item | Racks (German standard) | | | | |
|-----------------|-------------------------|------------------|-------------------|--------------------|-------------|
| | Nominal power (VA) | Active power (W) | Backup time (min) | Number of cabinets | Weight (kg) |
| 3 103 79 | 1250 | 875 | 13 | 1 | 23.5 |
| 3 103 81 | 2500 | 1750 | 13 | 1 | 34 |
| 3 103 83 | 3750 | 2625 | 13 | 1 | 43 |
| 3 103 85 | 5000 | 3500 | 13 | 1 | 53 |

| Item | Racks (French standard) | | | | |
|-----------------|-------------------------|------------------|-------------------|--------------------|-------------|
| | Nominal power (VA) | Active power (W) | Backup time (min) | Number of cabinets | Weight (kg) |
| 3 103 34 | 1250 | 875 | 13 | 1 | 23.5 |
| 3 103 35 | 2500 | 1750 | 13 | 1 | 34 |
| 3 103 36 | 3750 | 2625 | 13 | 1 | 43 |
| 3 103 37 | 5000 | 3500 | 13 | 1 | 53 |

| Item | Racks (British standard) | | | | |
|-----------------|--------------------------|------------------|-------------------|--------------------|-------------|
| | Nominal power (VA) | Active power (W) | Backup time (min) | Number of cabinets | Weight (kg) |
| 3 103 38 | 1250 | 875 | 13 | 1 | 23.5 |
| 3 103 39 | 2500 | 1750 | 13 | 1 | 34 |
| 3 103 40 | 3750 | 2625 | 13 | 1 | 43 |
| 3 103 41 | 5000 | 3500 | 13 | 1 | 53 |

| Item | Racks - without batteries | | | | |
|-----------------|---------------------------|------------------|-------------------|--------------------|-------------|
| | Nominal power (VA) | Active power (W) | Backup time (min) | Number of cabinets | Weight (kg) |
| 3 103 80 | 1250 | 875 | - | 1 | 23.5 |
| 3 103 82 | 2500 | 1750 | - | 1 | 34 |
| 3 103 84 | 3750 | 2625 | - | 1 | 43 |
| 3 103 86 | 5000 | 3500 | - | 1 | 53 |

| Item | Backup time extensions | | |
|-----------------|------------------------|---------------|-----------------|
| | Nominal power (VA) | Additional BK | Expansion (min) |
| 3 103 87 | 1250 | 1 | 30 |
| 3 103 88 | 1250 | 2 | 52 |
| 3 103 89 | 1250 | 3 | 75 |
| 3 103 90 | 2500 | 1 | 22 |
| 3 103 91 | 2500 | 2 | 30 |
| 3 103 92 | 3750 | 1 | 18 |

Battery expansions for Rack UPS

| | |
|-----------------|-----------------------------|
| 3 107 96 | Rack with 1 bk |
| 3 107 97 | Rack with 2 bk |
| 3 107 98 | Rack with 3 bk |
| 3 107 99 | Rack with 4 bk |
| 3 108 00 | Rack with 1 bk with charger |
| 3 108 01 | Rack with 2 bk with charger |
| 3 108 02 | Rack with 3 bk with charger |
| 3 108 03 | Rack with 4 bk with charger |

Accessories

| | |
|-----------------|---|
| 3 108 35 | Power module (PW 1250) |
| 3 108 77 | Manual bypass for single cabinet (BP/1) |
| 3 107 85 | Additional charger (CB 36) |
| 3 109 72 | Relay interface kit |
| 3 109 73 | Telescopic runner kit for 6U rack |

bk: battery kit

NOTE: The stated backup times in minutes are estimated and may vary according to the load characteristics, operating conditions and environment.

For the choice of communication accessories, see the dedicated section of this catalogue.

Megaline and Megaline Rack

Modular single-phase double conversion UPS VFI

Characteristics

| General Characteristics | 3 103 42 | 3 103 43 | 3 103 44 | 3 103 45 | 3 103 60 + 3 107 78 | 3 103 63 + 3 107 79 | 3 103 66 + 3 107 80 | 3 103 69 + 3 107 81 | 3 103 72 + 3 107 82 |
|---------------------------------------|--|----------------------------|----------|----------|------------------------|------------------------|------------------------|------------------------|------------------------|
| | 3 103 46 | 3 103 47 | 3 103 48 | 3 103 49 | | | | | |
| | 3 103 50 | 3 103 52 | 3 103 54 | 3 103 56 | | | | | |
| | 3 103 34 | 3 103 35 | 3 103 36 | 3 103 37 | | | | | |
| | 3 103 38 | 3 103 39 | 3 103 40 | 3 103 41 | | | | | |
| | 3 103 79 | 3 103 81 | 3 103 83 | 3 103 85 | | | | | |
| | | Single CABINET and RACK | | | Double CABINET | | | | |
| Nominal power (VA) | 1250 | 2500 | 3750 | 5000 | 5000 | 6250 | 7500 | 8750 | 10000 |
| Active power (W) | 875 | 1750 | 2625 | 3500 | 3500 | 4375 | 5250 | 6125 | 7000 |
| Max. expansion (VA) | 5000 | | | | 10000 | | | | |
| Max. expansion (W) | 3500 | | | | 7000 | | | | |
| Technology | On-Line double conversion (VFI-SS-111) | | | | | | | | |
| UPS Architecture | Modular, expandable, redundant N+X with 1250 VA Power modules, contained in one single Cabinet/ Rack | | | | | | | | |
| Input | | | | | | | | | |
| Nominal input voltage | 230 V | | | | | | | | |
| Input voltage range | 184 - 264 VAC at 100% load | | | | | | | | |
| Minimum operating voltage | 100 VAC at 50% load | | | | | | | | |
| THD Input current | < 3% | | | | | | | | |
| Input Power Factor | > 0.99 from 20% load | | | | | | | | |
| Input frequency | 50 Hz / 60 Hz ± 2% autosensing | | | | | | | | |
| Output | | | | | | | | | |
| Output voltage | 230 V ± 1% | | | | | | | | |
| Frequency output | 50 Hz / 60 Hz synchronised | | | | | | | | |
| THD Output Voltage | < 1% with non-linear load | | | | | | | | |
| Waveform | Sinusoidal | | | | | | | | |
| Peak Factor | 3:1 | | | | | | | | |
| Efficiency | up to 92% | | | | | | | | |
| Overload capacity | 300% for 1 sec, 200% for 5 sec, 150% for 30 sec | | | | | | | | |
| Batteries | | | | | | | | | |
| Backup time extension | Yes | | | | | | | | |
| Accessories supplied | | | | | | | | | |
| Bypass | Automatic, internally synchronised, static and electromechanical (for overloads and operating problems) | | | | | | | | |
| Alarms and signals | Wide screen with 4 alphanumeric lines, multi-coloured status indicator, audible signalling | | | | | | | | |
| Communication ports | 1 RS232 port 2 logic level ports | | | | | | | | |
| Protections | Electronic devices for protection against overloads, short-circuits and excessive battery discharge. Operation stops at end of Backup time. Inrush current limiter on start-up. Sensor for correct neutral switching. Back-feed protection (electrical safety insulation of the input plug during battery-based operation). EPO (emergency power off) contact. | | | | | | | | |
| IN/ OUT mains connection | German standard/terminal connector with universal multi-socket outlet (Italian/German standard) | | | | | | | | |
| Mechanical characteristics | | | | | | | | | |
| Net weight (kg) | 23.5 | 34 | 43 | 53 | 24 + 50 | 26.5+57.5 | 29 + 65 | 31.5+72.5 | 34 + 80 |
| Megaline Dimensions (HxWxD) (mm) | 475 x 270 x 570 | | | | 2 x 475 x 270 x 570 | | | | |
| Megaline Rack Dimensions (HxWxD) (mm) | 266 x 483 x 582 | | | | - | | | | |
| Power modules installed | 1 | 2 | 3 | 4 | 4 | 5 | 6 | 7 | 8 |
| Free power expansion slots | 3 | 2 | 1 | - | 4 | 3 | 2 | 1 | - |
| Installed battery kits | 1 | 2 | 3 | 4 | 4 | 5 | 6 | 7 | 8 |
| Free backup extension slots | 3 | 2 | 1 | - | 6 | 5 | 4 | 3 | 2 |
| Ambient conditions | | | | | | | | | |
| Operating temperature (°C) | 0 – 40 | | | | | | | | |
| Protection rating | IP20 | | | | | | | | |
| Relative humidity (%) | < 95% (non condensing) | | | | | | | | |
| Noise at 1 m from the unit (dBA) | < 40 | | | | | | | | |
| Certifications | | | | | | | | | |
| Standards | EN 62040-1, EN 62040-2, EN 62040-3 | | | | | | | | |
| Warranty | | | | | | | | | |
| Standard Warranty | 2 years with the On Site formula batteries included, interventions c/o the installation location | | | | | | | | |

Megaline and Megaline Rack

Modular single-phase double conversion UPS VFI

Long backup time table for single and double cabinet versions

| Model | Power | Back-up time | no. cabinets and dimensions HxWxD (mm) | Codes |
|-----------------------|-----------|--------------|--|-------------------------------------|
| Single Cabinet | | | | |
| | 1,250 VA | 30' | 1x (270 x 475 x 570) | 3 103 73 |
| | 1,250 VA | 52' | 1x (270 x 475 x 570) | 3 103 74 |
| | 1,250 VA | 75' | 1x (270 x 475 x 570) | 3 103 75 |
| | 2,500 VA | 22' | 1x (270 x 475 x 570) | 3 103 76 |
| | 2,500 VA | 30' | 2x (270 x 475 x 570) | 3 103 77 |
| | 2,500 VA | 52' | 2x (270 x 475 x 570) | 3 103 52 + 3 107 78 |
| | 2,500 VA | 63' | 2x (270 x 475 x 570) | 3 103 52 + 3 107 79 |
| | 3,750 VA | 18' | 1x (270 x 475 x 570) | 3 103 78 |
| | 3,750 VA | 29' | 2x (270 x 475 x 570) | 3 103 54 + 3 107 77 |
| | 3,750 VA | 44' | 2x (270 x 475 x 570) | 3 103 54 + 3 107 79 |
| | 3,750 VA | 67' | 2x (270 x 475 x 570) | 3 103 54 + 3 107 82 |
| | 5,000 VA | 22' | 2x (270 x 475 x 570) | 3 103 56 + 3 107 76 |
| | 5,000 VA | 30' | 2x (270 x 475 x 570) | 3 103 56 + 3 107 78 |
| | 5,000 VA | 46' | 2x (270 x 475 x 570) | 3 103 56 + 3 107 81 |
| | 5,000 VA | 63' | 2x (270 x 475 x 570) | 3 103 56 + 3 107 84 |
| Double Cabinet | | | | |
| | 5,000 VA | 22' | 2x (270 x 475 x 570) | 3 103 60 + 3 107 80 |
| | 5,000 VA | 30' | 2x (270 x 475 x 570) | 3 103 60 + 3 107 82 |
| | 5,000 VA | 46' | 3x (270 x 475 x 570)* | 3 103 60 + 3 107 84 + 3 107 75 |
| | 5,000 VA | 63' | 3x (270 x 475 x 570)* | 3 103 60 + 3 107 84 + 3 107 78 |
| | 6,250 VA | 20' | 2x (270 x 475 x 570) | 3 103 63 + 3 107 81 |
| | 6,250 VA | 30' | 2x (270 x 475 x 570) | 3 103 63 + 3 107 84 |
| | 6,250 VA | 47' | 3x (270 x 475 x 570)* | 3 103 63 + 3 107 84 + 3 107 78 |
| | 6,250 VA | 60' | 3x (270 x 475 x 570)* | 3 103 63 + 3 107 84 + 3 107 81 |
| | 7,500 VA | 18' | 2x (270 x 475 x 570) | 3 103 66 + 3 107 82 |
| | 7,500 VA | 30' | 3x (270 x 475 x 570)* | 3 103 66 + 3 107 84 + 3 107 76 |
| | 7,500 VA | 48' | 3x (270 x 475 x 570)* | 3 103 66 + 3 107 84 + 3 107 81 |
| | 7,500 VA | 59' | 3x (270 x 475 x 570)* | 3 103 66 + 3 107 84 (x2) |
| | 8,750 VA | 20' | 2x (270 x 475 x 570) | 3 103 69 + 3 107 84 |
| | 8,750 VA | 30' | 3x (270 x 475 x 570)* | 3 103 69 + 3 107 84 + 3 107 78 |
| | 8,750 VA | 45' | 3x (270 x 475 x 570)* | 3 103 69 + 3 107 84 + 3 107 83 |
| | 8,750 VA | 61' | 4x (270 x 475 x 570)* | 3 103 69 + 3 107 84 (x2) + 3 107 78 |
| | 10,000 VA | 22' | 3x (270 x 475 x 570)* | 3 103 72 + 3 107 84 + 3 107 76 |
| | 10,000 VA | 30' | 3x (270 x 475 x 570)* | 3 103 72 + 3 107 84 + 3 107 80 |
| | 10,000 VA | 46' | 4x (270 x 475 x 570)* | 3 103 72 + 3 107 84 (x2) + 3 107 76 |
| | 10,000 VA | 60' | 4x (270 x 475 x 570)* | 3 103 72 + 3 107 84 (x2) + 3 107 81 |

* The configuration requires the use of a Y 3 108 60 connection cable (the number of cables required is equal to the no. of cabinets -2)

Long backup time table for rack versions

| Model | Power | Back-up time | no. cabinets and dimensions HxWxD (mm) | Codes |
|-------------|----------|--------------|---|-------------------------------------|
| Rack | | | | |
| | 1,250 VA | 30' | 1 (6U) | 3 103 87 |
| | 1,250 VA | 52' | 1 (6U) | 3 103 88 |
| | 1,250 VA | 75' | 1 (6U) | 3 103 89 |
| | 2,500 VA | 22' | 1 (6U) | 3 103 90 |
| | 2,500 VA | 30' | 1 (6U) | 3 103 91 |
| | 2,500 VA | 52' | 2 (6U + 3U) | 3 103 81 + 3 107 99 |
| | 2,500 VA | 63' | 3 (6U + 2x3U) | 3 103 81 + 3 107 99 + 3 107 96 |
| | 3,750 VA | 18' | 1 (6U) | 3 103 92 |
| | 3,750 VA | 29' | 2 (6U + 3U) | 3 103 83 + 3 107 98 |
| | 3,750 VA | 44' | 3 (6U + 2x3U) | 3 103 83 + 3 107 99 + 3 107 96 |
| | 3,750 VA | 67' | 3 (6U + 3x3U) | 3 103 83 + 3 107 99 (x2) |
| | 5,000 VA | 22' | 2 (6U + 3U) | 3 103 85 + 3 107 97 |
| | 5,000 VA | 30' | 2 (6U + 2x3U) | 3 103 85 + 3 107 99 |
| | 5,000 VA | 46' | 3 (6U + 3x3U) | 3 103 85 + 3 107 99 + 3 107 98 |
| | 5,000 VA | 63' | 4 (6U + 4x3U) | 3 103 85 + 3 107 97 + 3 107 99 (x2) |
| | | | 6U= 483 x 266 x 582 3U= 483 x 133x 584 | |

NOTE: the stated backup times in minutes are estimated and may vary according to the load characteristics, operating conditions and environment.

Trimod HE

Modular three-phase double conversion UPS VFI



3 104 42



3 108 71



3 108 45

Characteristics:

- Modular three-phase UPS
- Power from 1 to 80 kVA
- On-Line double conversion VFI-SS-111
- High efficiency up to 96%
- Output factor 1
- Adaptable, redundant and scalable solutions (IN/OUT 3-1 phase configuration)
- Quick and simple maintenance
- Low environmental impact
- Diagnostics, monitoring, historical data and parameters that can be set on the screen
- Reduced foot print and dimensions
- Taller cabinet to extend backup time and standard configurations
- Multi control board function
- Dual Input Function
- Hot Swap system
- Menu available in 7 languages
- Frequency converter in 40-70Hz out 50/60Hz (selectable)
- Operations with genset
- Three independent phase outputs
- Bypass line input
- Eco Mode
- EPS Mode
- Output voltage adjustable in 1 volt steps (190÷245V)
- Bypass speed regulation
- Event log complete with date and time
- Global and historic data of each power module

| Item | UPS | Power (kVA) | Back-up time (min.) | No. and Type Cabinet | Weight (kg) |
|-------------------------|-----|-------------|---------------------|----------------------|-------------|
| 3 104 42 | | 10 | 11 | 1A | 167 |
| 3 104 43 | | 10 | 21 | 1A | 223 |
| 3 104 44 | | 10 | 35 | 1A | 279 |
| 3 104 02 | | 10 | 49 | 1B | 350 |
| 3 104 45 | | 15 | 13 | 1A | 220 |
| 3 104 46 | | 15 | 21 | 1A | 279 |
| 3 104 07 | | 15 | 29 | 1B | 350 |
| 3 104 47 | | 20 | 9 | 1A | 220 |
| 3 104 48 | | 20 | 14 | 1A | 279 |
| 3 104 13 | | 20 | 20 | 1B | 350 |
| 3 104 17 | | 30 | 8 | 1B | 325 |
| 3 104 19 + 3 107 63 | | 40 | 8 | 2A | 564 |
| 3 104 20 + 2 x 3 107 63 | | 60 | 10 | 3A | 830 |
| 3 110 08+3 104 78 | | 80 | 9 | 2B | 992 |

Cabinet A h=1370, Cabinet B h=1650

| Item | Accessories |
|----------|--|
| 3 108 69 | Output module 3.4 kVA |
| 3 108 71 | Output module 5 kVA |
| 3 108 73 | Output module 6.7 kVA |
| 3 108 51 | Additional battery charger module 15 A |

| Item | Battery accessories |
|----------|--|
| 3 108 54 | Kit of 4 empty battery drawers |
| 3 108 45 | Single drawer with 5 9Ah long life batteries (installed in multiples of 4) |
| 3 108 75 | Single drawer with 5 9Ah long life batteries (installed in multiples of 4) |
| 3 109 29 | Kit for separate batteries (only for 60-80 kVA) |

| Item | Additional empty battery cabinet |
|----------|-----------------------------------|
| 3 108 05 | 16-drawer modular battery cabinet |
| 3 108 06 | 20-drawer modular battery cabinet |

| Item | Additional battery cabinet with 9Ah batteries |
|----------|---|
| 3 107 60 | 4-drawer modular battery cabinet |
| 3 107 61 | 8-drawer modular battery cabinet |
| 3 107 62 | 12-drawer modular battery cabinet |
| 3 107 63 | 16-drawer modular battery cabinet |
| 3 107 64 | 20-drawer modular battery cabinet |

NOTE: the stated backup times in minutes are estimated and may vary according to the load characteristics, operating conditions and environment.

| Item | Power cabinet | Power (kVA) | No. of installable battery drawers | No. of phases | Type Cabinet | Weight (kg) |
|----------|---------------|-------------|------------------------------------|-----------------------|--------------|-------------|
| 3 103 96 | | 10 | 12 | 1-1 / 3-3 / 3-1 / 1-3 | A | 120 |
| 3 103 97 | | 10 | 16 | 1-1 / 3-3 / 3-1 / 1-3 | B | 155 |
| 3 104 08 | | 15 | 12 | 1-1 / 3-3 / 3-1 / 1-3 | A | 120 |
| 3 104 03 | | 15 | 16 | 1-1 / 3-3 / 3-1 / 1-3 | B | 155 |
| 3 104 14 | | 20 | 12 | 1-1 / 3-3 / 3-1 / 1-3 | A | 120 |
| 3 104 09 | | 20 | 16 | 3-3 | B | 155 |
| 3 104 18 | | 30 | - | 3-3 | A | 146 |
| 3 104 15 | | 30 | 12 | 3-3 | B | 181 |
| 3 104 19 | | 40 | - | 3-3 | A | 146 |
| 3 104 20 | | 60 | - | 3-3 | A | 165 |
| 3 110 08 | | 80 | - | 3-3 | B | 220 |

| Item | Power cabinets (empty) | No. of installable power modules | No. of installable battery drawers | No. of phases | Type Cabinet | Weight (kg) |
|----------|------------------------|----------------------------------|------------------------------------|-----------------------|--------------|-------------|
| 3 104 22 | | 3 x 3.4 kVA | 12 | 1-1 / 3-3 / 3-1 / 1-3 | A | 85 |
| 3 104 31 | | 3 x 3.4 kVA | 16 | 1-1 / 3-3 / 3-1 / 1-3 | B | 98 |
| 3 104 23 | | 3 x 5.0 / 6.7 kVA | 12 | 1-1 / 3-3 / 3-1 / 1-3 | A | 90 |
| 3 104 32 | | 6 x 3.4 kVA | 12 | 1-1 / 3-3 / 3-1 / 1-3 | B | 102 |
| 3 104 33 | | 3 x 5.0 / 6.7 kVA | 16 | 1-1 / 3-3 / 3-1 / 1-3 | B | 102 |
| 3 104 24 | | 6 x 5 kVA | - | 3-3 | A | 80 |
| 3 104 25 | | 6 x 5 kVA | - | 1-1/3-3/3-1/1-3 | A | 84 |
| 3 104 34 | | 6 x 5 kVA | 12 | 3-3 | B | 104 |
| 3 104 26 | | 6 x 6.7 kVA | - | 3-3 | A | 80 |
| 3 104 27 | | 9 x 6.7 kVA | - | 3-3 | A | 90 |

| Item | Power cabinets with MULTI CONTROL BOARD (empty) | No. of installable power modules | No. of installable battery drawers | No. of phases | Type Cabinet | Weight (kg) | No. of controls |
|----------|---|----------------------------------|------------------------------------|-----------------|--------------|-------------|-----------------|
| 3 104 68 | | 6 x 3.4 or 5 kVA | - | 1-1/3-3/3-1/1-3 | A | 85 | 2 |
| 3 104 69 | | 6 x 5 kVA | 12 | 3-3 | B | 106 | 2 |
| 3 104 71 | | 6 x 6.7 kVA | - | 3-3 | A | 82 | 2 |
| 3 104 72 | | 9 x 6.7 kVA | - | 3-3 | A | 91 | 3 |
| 3 104 73 | | 12 x 6.7 kVA | - | 3-3 | B | 120 | 4 |

| Item | Additional battery cabinet with long life batteries |
|----------|---|
| 3 104 70 | Battery cabinet for Trimod type A |
| 3 104 78 | Battery cabinet for Trimod type B |



For the choice of communication accessories, see the dedicated section of this catalogue.

Trimod HE

Modular three-phase double conversion UPS VFI

Characteristics

| General Characteristics | 3 103 96 | 3 104 03 | 3 104 09 | 3 104 15* | 3 104 19 | 3 104 20 | 3 104 73 |
|--|--|----------|--------------|-----------------------------------|----------|--------------|----------|
| | 3 103 97 | 3 104 08 | 3 104 14 | 3 104 18* 3 104 68 3 104 69 | 3 104 71 | 3 104 72 | 3 110 08 |
| Nominal power (kVA) | 10 | 15 | 20 | 30 | 40 | 60 | 80 |
| Active power (kW) | 10 | 15 | 20 | 30 | 40 | 60 | 80 |
| Module power (kVA) | 3.4 | 5 | 6.7 | 5 | 6.7 | 6.7 | 6.7 |
| Technology | On-Line Double Conversion VFI-SS-111 | | | | | | |
| System | Modular, expandable and redundant UPS system | | | | | | |
| Input specifications | | | | | | | |
| Input voltage | 380, 400, 415 3F+N+PE (or 220, 230, 240 1F) | | | 380, 400, 415 3F+N+PE | | | |
| Input frequency | 45-65 Hz (43,0 ÷ 68,4 Hz) | | | | | | |
| Input voltage range | 400V +15%/-20% - 230V +15%/-20% | | | 400V +15%/-20% | | | |
| THD Input current | < 3% (at full load) | | | | | | |
| Compatibility with genset | Yes | | | | | | |
| Input Power Factor | > 0.99 | | | | | | |
| Output Specifications | | | | | | | |
| Output voltage | 380, 400, 415 3F+N+PE (or 220, 230, 240 1F) | | | 380, 400, 415 3F+N+PE | | | |
| Efficiency | Up to 96% | | | | | | |
| Efficiency in Eco Mode | 99% | | | | | | |
| Nominal output frequency | 50/60 Hz selectable by the user ±2 % (standard), ±14 % (extended) | | | | | | |
| Peak factor | 3:1 | | | | | | |
| Waveform | Sinusoidal | | | | | | |
| Output Voltage Tolerance | ±1% | | | | | | |
| THD Output Voltage | < 1% | | | | | | |
| Overload capacity | 10 minutes at 115%, 60 seconds at 135% | | | | | | |
| Bypass | Automatic bypass (static and electromechanical) and manual maintenance bypass | | | | | | |
| Batteries | | | | | | | |
| Battery module | Plug & Play | | | | | | |
| Battery series type/voltage | VRLA - AGM /240 Vd.c. | | | | | | |
| Back-up time | Configurable | | | | | | |
| Battery charger | Smart Charge Technology. 3-stage advanced cycle | | | | | | |
| Independent battery configuration | No | | Yes | | | Yes with KIT | |
| Communication and management | | | | | | | |
| Screen and signalling | 4 20-character rows, 4 menu navigation buttons, multi-colour LED status indicator, alarms and acoustic signals | | | | | | |
| Communication ports | 2 RS232 ports, 1 logic level port, 5 floating contact ports, 1 interface slot | | | | | | |
| Back feed protection | NC/NO auxiliary contact | | | | | | |
| Emergency Power Off (EPO) | Yes | | | | | | |
| Remote control | Available | | | | | | |
| Mechanical characteristics | | | | | | | |
| Height A-B (mm) | 1370 - 1650 | | | | | | |
| Width (mm) | 414 | 414 | 414 | 414 | 414 | 414 | 414 |
| Depth (mm) | 628 | 628 | 628 | 628 | 628 | 628 | 628 |
| Number of Installed Power Modules | 3 | 6 | 6 | 9 | 12 | | |
| Installable battery drawers (A-B) | Up to 12 - Up to 16 | | Up to 0 - 12 | | - | - | - |
| Net weight A-B (kg) | Refer to the previous page, where there are the weights of the various configurations | | | | | | |
| Ambient Conditions | | | | | | | |
| Operating temperature/humidity | 0 - 40°C / 0 - 95% non condensing | | | | | | |
| Protection rating | IP21 | | | | | | |
| Noise at 1 m from the unit (dBA) | 58-62 | | | | | | |
| Estimated content of circular economy derived materials | | | | 37% | | | |
| Recyclability rate calculated using the method described in technical report IEC/TR 62635** | | | | 84% | | | |
| Certifications | | | | | | | |
| Standards | EN 62040-1, EN 62040-2, EN 62040-3 | | | | | | |
| Services | | | | | | | |
| Installation | User executable, modular architecture with "Plug & Play" power modules and batteries | | | | | | |
| Maintenance | User executable, availability of optional services provided by the manufacturer | | | | | | |
| Ease of management | Advanced diagnostic functions via the touch screen display | | | | | | |

* Standard configurations with 3-3 distribution (multi IN/OUT settings available upon request)

** This value is based on data collected from a technological channel operating on an industrial basis. It does not pre-validate the effective use of this channel for end-of-life of this product.

Trimod HE

Long backup times table



Modular battery cabinet
with up to 20
battery drawers installable
Total - 100 Batteries



Non modular
battery cabinet
up to 20 battery
drawers installable*

| Trimod HE | Battery cabinet type | Nominal power (kVA) | Back-up time | Dimensions HxWxD (mm) | Weight (kg) |
|-------------------------|----------------------|---------------------|--------------|---|-------------|
| 3 104 44 + 3 107 61 | modular | 10 | 78 | 2 x 1370 x 414 x 628 | 472 |
| 3 104 46 + 3 107 60 | modular | 15 | 33 | 2 x 1370 x 414 x 628 | 413 |
| 3 104 08 + 3 104 78 | non modular | 15 | 110 * | 1370 x 414 x 628 + 1635 x 600 x 800 | 902 |
| 3 104 46 + 3 107 63 | modular | 15 | 57 | 2 x 1370 x 414 x 628 | 550 |
| 3 104 48 + 3 107 62 | modular | 20 | 35 | 2 x 1370 x 414 x 628 | 572 |
| 3 104 14 + 3 104 78 | non modular | 20 | 82 * | 1370 x 414 x 628 + 1635 x 600 x 800 | 865 |
| 3 104 18 + 3 107 63 | modular | 30 | 12 | 2 x 1370 x 414 x 628 | 434 |
| 3 104 18 + 3 104 78 | non modular | 30 | 50 * | 1370 x 414 x 628 + 1635 x 600 x 800 | 890 |
| 3 104 18 + 2 x 3 104 78 | non modular | 30 | 110 * | 1370 x 414 x 628 + 2 x 1635 x 600 x 800 | 1645 |
| 3 104 19 + 2 x 3 107 63 | modular | 40 | 20 | 3 x 1370 x 414 x 628 | 801 |
| 3 104 19 + 3 108 10 | non modular | 40 | 33 * | 1370 x 414 x 628 + 1635 x 600 x 800 | 925 |
| 3 104 19 + 2 x 3 104 78 | non modular | 40 | 82 * | 1370 x 414 x 628 + 2 x 1635 x 600 x 800 | 1700 |
| 3 104 19 + 3 x 3 104 78 | non modular | 40 | 120 * | 1370 x 414 x 628 + 3 x 1635 x 600 x 800 | 2430 |
| 3 104 19 + 3 x 3 107 64 | modular | 40 | 40 | 1370 x 414 x 628 + 3 x 1650 x 414 x 628 | 439 |
| 3 104 19 + 4 x 3 107 64 | modular | 40 | 60 | 1370 x 414 x 628 + 4 x 1650 x 414 x 628 | 1663 |
| 3 104 20 + 2 x 3 107 64 | modular | 60 | 15 | 1370 x 414 x 628 + 2 x 1650 x 414 x 628 | 942 |
| 3 104 20 + 4 x 3 107 63 | modular | 60 | 27 | 5 x 1370 x 414 x 628 | 1579 |
| 3 104 20 + 3 104 78 | non modular | 60 | 17 * | 1370 x 414 x 628 + 1635 x 600 x 800 | 952 |
| 3 104 20 + 2 x 3 104 78 | non modular | 60 | 50 * | 1370 x 414 x 628 + 2 x 1635 x 600 x 800 | 1715 |
| 3 104 20 + 3 x 3 104 78 | non modular | 60 | 80 * | 1370 x 414 x 628 + 3 x 1635 x 600 x 800 | 2474 |
| 3 104 20 + 4 x 3 104 78 | non modular | 60 | 110 * | 1370 x 414 x 628 + 4 x 1635 x 600 x 800 | 3234 |
| 3 110 08 + 2 x 3 104 70 | non modular | 80 | 20 | 1650X414X628+2X1635X600X800 | 1622 |
| 3 110 08 + 2 x 3 104 78 | non modular | 80 | 30 | 1650X414X628+2X1635X600X800 | 1782 |
| 3 110 08 + 3 x 3 104 78 | non modular | 80 | 47 | 1650X414X628+3X1635X600X800 | 2572 |
| 3 110 08 + 4 x 3 104 78 | non modular | 80 | 67 | 1650X414X628+4X1635X600X800 | 1782 |

* Configurations with long life battery cabinets.
310470 LONG LIFE BATTERY CABINET MODEL A - 710 kg - 600x800x1635 mm
310478 LONG LIFE BATTERY CABINET MODEL b - 790 kg - 600x800x1635 mm

NOTE: the stated backup times in minutes are estimated and may vary according to the load characteristics, operating conditions and environment.

Trimod MCS

CPS Modular three-phase double conversion VFI

**EN STANDARD
50171**



3 109 90



3 110 02



3 108 71



3 108 75

Characteristics:

- Modular single-phase and three-phase CPS
- Power from 3 to 80 kVA
- Conforms to EN-50171 Standards
- On-Line double conversion VFI-SS-111
- High efficiency up to 96%
- Output factor 1
- Adaptable, redundant and scalable solutions (IN/OUT 3-1 phase configuration)
- Quick and simple maintenance
- Low environmental impact
- Diagnostics, monitoring, historical data and parameters that can be set on the screen
- Reduced foot print and dimensions
- Taller cabinet to extend backup time and standard configurations
- Pre-configured solutions with 1h backup time
- Dual input function (Bypass line input)
- Hot Swap system
- Continuous operations at up to 120% of the load
- Protection against battery pole inversion
- Output configurable from the display as PERMANENT or NON PERMANENT
- Menu available in 7 languages
- Frequency converter in 40-70Hz out 50/60Hz (selectable)
- Operations with genset
- Three independent phase outputs
- Eco Mode
- Bypass speed regulation
- Event log complete with date and time
- Global and historic data of each power module

Item Accessories

| | |
|-----------------|-----------------------|
| 3 108 69 | Output module 3.4 kVA |
| 3 108 71 | Output module 5 kVA |
| 3 108 73 | Output module 6.7 kVA |

Battery accessories

| | |
|-----------------|--|
| 3 108 75 | Single drawer with 5 9Ah long life batteries (installed in multiples of 4) |
|-----------------|--|

Additional empty battery cabinet

| | |
|-----------------|-----------------------------------|
| 3 110 07 | 16-drawer modular battery cabinet |
| 3 106 16 | 20-drawer modular battery cabinet |

Additional battery cabinet with batteries Long Life

| | |
|-----------------|--|
| 3 106 18 | Modular battery cabinet with 3KB for CPS 10 KVA |
| 3 106 19 | Modular battery cabinet with 5 KB for CPS 15 KVA |
| 3 104 70 | Battery cabinet for CPS type A |
| 3 104 78 | Battery cabinet for CPS type B |

Trimod MCS (Empty CPS Cabinets)

| | N° of installable power modules | N° of installable battery drawers | No. of phases | Type Cabinet | Weight (kg) |
|-----------------|---------------------------------|-----------------------------------|-----------------------|--------------|-------------|
| 3 110 00 | up to 3 to 3.4 kVA | 12 | 1-1 / 3-3 / 3-1 / 1-3 | A | 86 |
| 3 110 01 | up to 3 to 6.7 kVA | 12 | 1-1 / 3-3 / 3-1 / 1-3 | A | 89 |
| 3 110 02 | up to 3 to 6.7 kVA | 16 | 1-1 / 3-3 / 3-1 / 1-3 | B | 103 |
| 3 110 03 | up to 6 to 5 kVA | - | 1-1 / 3-3 / 3-1 / 1-3 | A | 85 |
| 3 110 04 | up to 6 to 6.7 kVA | - | 3-3 | A | 82 |
| 3 110 05 | up to 9 to 6.7 kVA | - | 3-3 | A | 91 |
| 3 110 06 | up to 12 to 6.7 kVA | - | 3-3 | B | 120 |

| Item | Trimod MCS | | | |
|--------------------------------|------------|-------------------------------|----------------------|-------------------------|
| | Model | Autonomy according to EN50171 | No. and Type Cabinet | IN-OUT factory settings |
| 3 109 90 | 3 | 1h | 1A | 1-1 |
| 3 109 91 | 5 | 1h | 1A | 1-1 |
| 3 109 92 | 7 | 1h | 1B | 1-1 |
| 3 109 93 + 3 106 18 | 10 | 1h | 1B | 3-3 |
| 3 109 94 + 3 106 19 | 15 | 1h | 1B | 3-3 |
| 3 109 95 + 3 104 78 | 20 | 1h | 1A | 3-3 |
| 3 109 96 + 2 x 3 104 70 | 30 | 1h | 1A | 3-3 |
| 3 109 97 + 2 x 3 104 78 | 40 | 1h | 1A | 3-3 |
| 3 109 98 + 3 x 3 104 78 | 60 | 1h | 1A | 3-3 |
| 3 109 99 + 4 x 3 104 78 | 80 | 1h | 1B | 3-3 |

Cabinet A h=1370, Cabinet B h=1650

NOTE: the stated backup times are estimated and may vary according to the load characteristics, operating conditions and environment.

For the choice of communication accessories, see the dedicated section of this catalogue.

Trimod MCS

CPS Modular three-phase double conversion VFI

| Characteristics | | | | | | | | | | |
|--|--|----------|---------------------|---|------------------------|-----------------------|-----------------------------|-----------------------------|-----------------------------|-----------------------------|
| General Characteristics | 3 109 90 | 3 109 91 | 3 109 92 | 3 109 93+ 3 106 18 | 3 109 94+ 3 106 19 | 3 109 95+ 3 104 78 | 3 109 96+ 2x 3 104 70 | 3 109 97+ 2x 3 104 78 | 3 109 98+ 3x 3 104 78 | 3 109 99+ 4x 3 104 78 |
| Nominal power (kVA) | 3 | 5 | 6.7 | 10 | 15 | 20 | 30 | 40 | 60 | 80 |
| Active power (kW) | 3 | 5 | 6.7 | 10 | 15 | 20 | 30 | 40 | 60 | 80 |
| Active power according to EN50171 (kW) | 2.88 | 4.16 | 5.58 | 8 | 12.5 | 16.7 | 25 | 33.3 | 50 | 66.7 |
| Technology | On-Line Double Conversion VFI-SS-111 | | | | | | | | | |
| System | Modular, expandable and redundant UPS system | | | | | | | | | |
| Input specifications | | | | | | | | | | |
| Input voltage | 220,230,240 1F+N+PE | | | 380, 400, 415 3F+N+PE * (o 220, 230, 240 1F) | | | 380, 400, 415 3F+N+PE | | | |
| Input frequency | 45-65 Hz (43,0 ÷ 68,4 Hz) | | | | | | | | | |
| Input voltage range | 230V +15%/-20% | | | 400V +15%/-20% - 230V +15%/-20% | | | 400V +15%/-20% | | | |
| THD Input current | < 3% (at full load) | | | | | | | | | |
| Compatibility with power supply units | Yes | | | | | | | | | |
| Input power factor | > 0.99 | | | | | | | | | |
| Output Specifications | | | | | | | | | | |
| Output voltage | 220,230,240 1F+N+PE | | | 380, 400, 415 3F+N+PE * (o 220, 230, 240 1F) | | | 380, 400, 415 3F+N+PE | | | |
| Efficiency | Up to 96% | | | | | | | | | |
| Efficiency in Eco Mode | 99% | | | | | | | | | |
| Nominal output frequency | 50/60 Hz selectable by the user ±2 % (standard), ±14 % (extended) | | | | | | | | | |
| Peak factor | 3:1 | | | | | | | | | |
| Waveform | Sinusoidal | | | | | | | | | |
| Output voltage tolerance | ±1% | | | | | | | | | |
| THD output voltage | < 1% | | | | | | | | | |
| Overload capacity | 120% continuous, 10 minutes at 135%, 60 seconds at 150% | | | | | | | | | |
| Bypass | Automatic bypass (static and electromechanical) and manual maintenance bypass | | | | | | | | | |
| Batteries | | | | | | | | | | |
| Battery module | Plug & Play | | | | | | | | | |
| Type | Long Life | | | | | | | | | |
| Back-up time | 1h (settable as needed) | | | | | | | | | |
| Battery charger | 80% autonomy in 12h - Smart Charge technology. 3-stage advanced cycle | | | | | | | | | |
| Communication and management | | | | | | | | | | |
| Screen and signalling | 4 20-character rows, 4 menu navigation buttons, multi-colour LED status indicator, alarms and acoustic signals | | | | | | | | | |
| Communication Ports | 2 RS232 serial ports, 1 logic level port, 5 floating contact ports, 1 interface slot | | | | | | | | | |
| Back feed protection | NC/NO auxiliary contact | | | | | | | | | |
| Emergency Power Off (EPO) | Yes | | | | | | | | | |
| Remote management | Available | | | | | | | | | |
| Mechanical characteristics | | | | | | | | | | |
| Dimensions HxWxD (mm) | 1370 x 414 x 628 | | 1650 x 414 x 628 | 1370 x 414 x 628 | 1650 x 414 x 628 | 1370 x 414 x 628 | | | | 1650 x 414 x 628 |
| Net weight kg | 202.5 | 265.5 | 327.5 | 273.5 | 344.5 | 115 | 136 | 134 | 158.5 | 222 |
| Battery cabinet dimensions HxWxD (mm) | - | - | - | 1370x 414x 628 | 1650x 414x 628 | 600x 800x1635 | | | | |
| Battery cabinet net weight (kg) | - | - | - | 257 | 375 | 790 | 710 | 790 | | |
| Installable battery drawers | 8 | 12 | 16 | - | - | - | - | - | - | - |
| Ambient Conditions | | | | | | | | | | |
| Operating temperature/humidity | 0 - 40°C / 0 - 95% non condensing | | | | | | | | | |
| Protection rating | IP21 | | | | | | | | | |
| Noise at 1 m from the unit (dBA) | 58-62 | | | | | | | | | |
| Conformity | | | | | | | | | | |
| Certifications | EN 62040-1, EN 62040-2, EN 62040-3, EN 50171 | | | | | | | | | |
| Services | | | | | | | | | | |
| Installation | User executable, modular architecture with "Plug & Play" power modules and batteries | | | | | | | | | |
| Maintenance | Availability of optional services provided by the manufacturer | | | | | | | | | |
| Ease of management | Advanced diagnostic functions via the touch screen display | | | | | | | | | |

* Standard configurations with 3-3 distribution (multi IN/OUT settings available upon request)

Keor MOD

UPS Modular three-phase double conversion VFI



3 104 80

Characteristics:

- Two cabinet types only (up to 124 kV and 250 kVA)
- Integrated backup for powers of up to 125 kVA
- UPS system capacity up to 600 kVA
- 10" touch screen with inward swivel option
- Reduced battery charging times
- Double conversion efficiency over 96.8%.
- Efficiency in ECO mode up to 99%
- Output power factor up to 1
- Modular redundancy in N+1 configuration.
- Noise controlled with intelligent fan management
- Multicoloured front LED bar
- Parallelable system with up to 24 modules
- Hot Swap and Plug and Play system
- Reduced battery charging times
- Decentralised bypass.
- Intelligence distributed between the modules

| Item | UPS - empty power cabinets | | | |
|-----------------|----------------------------|--------------------------------|--------------|-------------|
| | Power (kVA) | Battery drawers socket-outlets | Distribution | Weight (kg) |
| 3 104 80 | 25 - 125 | from 2 to 5 battery drawers | 3-3 | 256 |
| 3 104 81 | 25 - 250 | - | 3-3 | 233 |

Accessories

- 3 106 75** Output module 25 kVA
- 3 106 76** Kit of empty 6 battery block (to be used in sets of 4 per drawer)
- 3 106 77** Kit of 2 EMPTY battery drawers
- 3 106 78** Kit of 4 battery blocks (each 6 x 9 Ah batteries)
- 3 106 79** Kit of 4 battery blocks (each 6 x 11 Ah batteries)
- 3 109 62** Kit of 4 battery blocks (each 6x 9 Ah Long Life batteries)
- 3 104 84** Modular battery cabinet
- 3 109 89** Full conventional battery cabinet*
- 3 109 75** Parallel cable kit (1 kit for every 2 cabinets - length 6m)

* to be used in multiples of 2



NOTE: the stated backup times in minutes are estimated and may vary according to the load characteristics, operating conditions and environment.

For the choice of communication accessories, see the dedicated section of this catalogue.

Configuration examples

UPS up to 125 kVA

- 25**
Power: 25 kVA
Back-up time: 48 min. when 100% charged
1 Power module
10 Battery drawers



UPS up to 250 kVA

- 50**
Power: 50 kVA
2 Power modules



75

- Power: 75 kVA
Back-up time: 11 min. when 100% charged
3 Power modules
10 Battery drawers



100

- Power: 100 kVA
4 Power modules



125

- Power: 125 kVA
Back-up time: 5.2 min. when 100% charged
5 Power modules



250

- Power: 250 kVA
10 Power modules



Keor MOD

UPS Modular three-phase double conversion VFI

| Characteristics | | | | | | | | | | |
|---|---|----|----|-----|-----|----------|-----|-----|-----|-----|
| General Characteristics | | | | | | | | | | |
| Nominal power (kVA) | 25 | 50 | 75 | 100 | 125 | 150 | 175 | 200 | 225 | 250 |
| Active power (kW) | 25 | 50 | 75 | 100 | 125 | 150 | 175 | 200 | 225 | 250 |
| Module power (kVA) | 25 | | | | | | | | | |
| Technology | On-Line double conversion VFI-SS-111 | | | | | | | | | |
| Number of power modules | 1 | 2 | 3 | 4 | 5 | 6 | 7 | 8 | 9 | 10 |
| System | Modular, expandable and redundant UPS system | | | | | | | | | |
| Input specifications | | | | | | | | | | |
| Input voltage | 400V 3F+N+PE | | | | | | | | | |
| Input frequency | 45-65 Hz (43,0 ÷ 68,4 Hz) | | | | | | | | | |
| Input voltage range | 400V +15%/-20% - 230V +15%/-20% | | | | | | | | | |
| THD input current | < 3% (at full load) | | | | | | | | | |
| Compatibility with power supply units | Yes | | | | | | | | | |
| Input power factor | > 0.99 | | | | | | | | | |
| Output Specifications | | | | | | | | | | |
| Output voltage | 380, 400, 415V | | | | | | | | | |
| Efficiency (power module) | Up to 96.8% | | | | | | | | | |
| System efficiency | Up to 96.5% | | | | | | | | | |
| Efficiency in Eco mode | 99% | | | | | | | | | |
| Nominal output frequency | 50/60 Hz selectable by the user ±2 % (standard), ±14 % (extended) | | | | | | | | | |
| Peak factor | 3:1 | | | | | | | | | |
| Waveform | Sinusoidal | | | | | | | | | |
| Output voltage tolerance | ±1% | | | | | | | | | |
| THD output voltage | <0.5% with linear load, <1% with non-linear load | | | | | | | | | |
| Overload capacity | 10 minutes at 125%, 60 seconds at 150% | | | | | | | | | |
| Bypass | Automatic bypass (static and electromechanical) and manual maintenance bypass | | | | | | | | | |
| Batteries | | | | | | | | | | |
| Battery module | Plug & play | | | | | | | | | |
| Battery series type/voltage | VRLA - AGM 12 V, 9 Ah - 11 Ah | | | | | | | | | |
| Back-up time | Configurable | | | | | | | | | |
| Battery charger | Smart charge technology. 3-stage advanced cycle | | | | | | | | | |
| Independent battery configuration | Yes, maximum 5 sets of independent batteries (configurable as common or separate units) | | | | | | | | | |
| Communication and management | | | | | | | | | | |
| Display | 10" rotating colour touch screen | | | | | | | | | |
| Communication ports | 2 x RS485 ports (one for external accessories), 11 input floating contacts, 8 output floating contacts, 1 network interface slot, USB host port | | | | | | | | | |
| Back feed protection | NC/NO auxiliary contact | | | | | | | | | |
| Emergency Power Off (EPO) | Yes | | | | | | | | | |
| Cold start push-button | Yes | | | | | | | | | |
| Remote control | Available | | | | | | | | | |
| Mechanical characteristics | | | | | | | | | | |
| Height (mm) | 1990 | | | | | | | | | |
| Width (mm) | 600 | | | | | | | | | |
| Depth (mm) | 1000 | | | | | | | | | |
| Installed power modules | up to 5 | | | | | up to 10 | | | | |
| Installable battery drawers | up to 10 | | | | | — | | | | |
| Net weight (kg) | 256 | | | | | 233 | | | | |
| Ambient Conditions | | | | | | | | | | |
| Operating temperature/humidity | 0 - 40°C / 0 - 95% non condensing | | | | | | | | | |
| Protection rating | IP20 | | | | | | | | | |
| Maximum audible noise at 1 m from the unit (dBA) | 50-65 | | | | | | | | | |
| Estimated content of circular economy derived materials | 43% | | | | | | | | | |
| Recyclability rate calculated using the method described in technical report IEC/TR 62635* | 74% | | | | | | | | | |
| Conformity | | | | | | | | | | |
| Certifications | EN 62040-1, EN 62040-2, EN 62040-3 | | | | | | | | | |
| Services | | | | | | | | | | |
| Installation | Modular architecture with "Plug & Play" power modules and batteries | | | | | | | | | |
| Maintenance | Availability of optional services provided by the manufacturer | | | | | | | | | |
| Ease of management | Advanced diagnostic functions via the touch screen display | | | | | | | | | |

* This value is based on data collected from a technological channel operating on an industrial basis. It does not pre-validate the effective use of this channel for end-of-life of this product.

CONVENTIONAL UPS

The **Legrand conventional UPS** units range in power from 10 kVA to 4.8 MVA and feature double conversion on-line technology, latest generation micro processors for accurate and constant control of all measurements, and a power factor correction (PFC) circuit.

Transformer-free technology electronics for high quality energy output with up to 96.4% efficiency.

These uninterruptible power supplies are the result of an accurate combination of technology and design and deliver high performance, reliability and ease of use and maintenance.

The high efficiency and low environmental impact make them the ideal solution in various application fields, often characterised by critical conditions such as hospitals, industries, transport and the various tertiary sectors.

The products that are part of this version are:

Keor Compact - Keor T Evo - Keor HP - Keor HPE - Keor XPE.



Keor XPE
from 600 kVA to 2.1 MVA



Keor Compact
from 10 to 20 kVA



Keor T Evo
from 10 to 60 kVA



Keor HP
from 100 to 800 kVA



Keor HPE
from 60 to 500 kVA

THE PERFECT
BALANCE BETWEEN
DIMENSIONS
AND **POWER**

The supplied internal batteries, with a capacity of up to 80 kVA, avoid additional costs for the purchase of external battery cabinets, help reduce the space occupied and simplify installation.



0.32 m²
(30 kVA, 20')



0.54 m²
(60 kVA, 14')



Range from 10 kVA to 4.8 MVA

High efficiency - up to 96%

Power factor =1



INTERNAL BATTERY FIXTURES

Excellent battery management

The advanced battery charge and management functions improve performance and operating life over time.

Front internal access

Legrand conventional UPS are designed to be installed and maintained from the front. All the manoeuvre switches and communication ports are installed on the front of the UPS. Ease of access to all parts subject to maintenance significantly reduces machine repair times.

CONVENTIONAL UPS

Parallelable system

It is possible to connect up to 6 identical power units in parallel depending on the power requirements. This achieves delivery of power levels of up to 4.8 MVA.

Scalability

The parallel connections of up to 6 UPS makes it possible to achieve different degrees of redundancy and maximum levels of continuity of service and safety of the system itself.

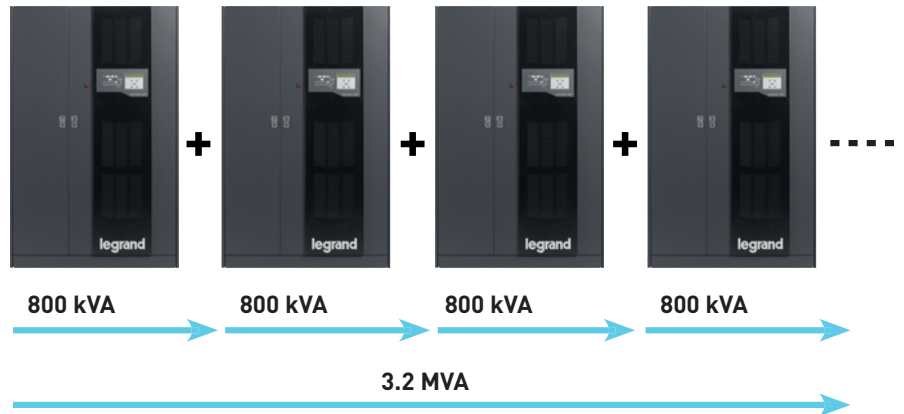

Keor HP

It is a sturdy UPS unit, equipped with an internal isolation transformer making it suitable for use in high electrical disturbance environments. Its nominal powers of from 100 to 800 kVA makes it ideal for high power applications in tertiary, hospital, industry and transportation sectors.



Keor XPE

It is a complete scalable UPS system based on 250 or 300 kVA power units that can be combined with others to achieve the required power level (up to 2.1 MVA) or create redundant configurations.

Keor XPE It is the ideal solution for Data Center and high power applications.

SPECIAL CARE FOR **DESIGN**

The elegance of the design and the skilful choice of materials complete the performance and reliability features of this series of UPS units.

The new user-friendly and intuitive touch-screen displays and the hexagonal pattern, also seen in the ventilation grids, enhance the product, combining technology and design.

Keor HPE

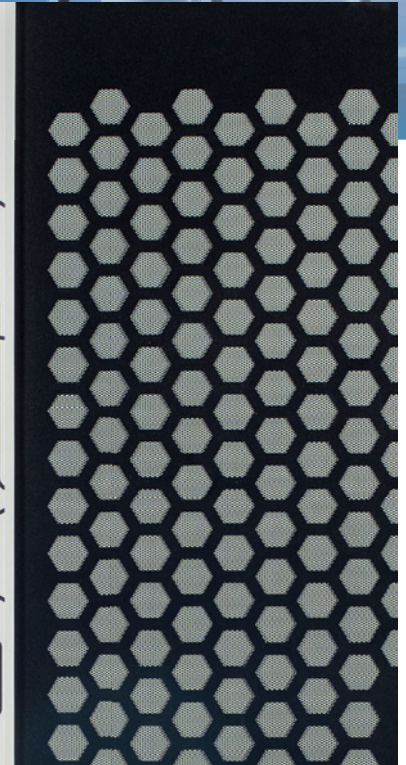

Keor T Evo

Its nominal powers of from 10 to 60 kVA provides a simple and compact solution for classic applications in tertiary, trade and industry sectors. Keor T Evo is scalable, parallelable and equipped with a display and multicoloured led bars that allow for swift UPS status checks.

Keor HPE



Keor HPE is the perfect solution for critical medium and large power applications and is available from 60 to 500 kVA versions.

Boasting attention to design and a smart display, it includes advanced battery charging and management features that guarantee top battery performance and maximum operating life.



Keor Compact

With a rated power of 10-15-20 kVA, this is an easy-to-install UPS with wheels and colour touchscreen with user-friendly graphics and navigation windows. Thanks to its small dimensions, Keor Compact is ideal for installation even in small technical rooms. Parallel connections for redundant configurations make this UPS the perfect solution also for critical applications.

Keor Compact

Conventional UPS - On-line three-phase double conversion VFI



3 111 00

Characteristics:

- PFC power-factor correction (input PF>0.99)
- 4.3" user friendly touch screen display
- Wide range of input voltages and frequencies
- Dual Input
- Cold Start
- Embedded backfeed protection
- Smart communication ports and SNMP management capability
- Parallelable system with up to 6 units
- Built-in battery for standard autonomy
- Extended backup time with battery cabinets
- Overload and short-circuit protection
- Powerful built-in loader
- RS232, dry contacts
- Compatibility with gensets
- Compact dimensions, lightweight and low noise
- Reduced footprint: 0.22 m²
- Wheels for ease of handling

| Item | UPS | | | |
|-----------------|---------------------|-------------------|---------------------------|-------------|
| | Nominal power (kVA) | Power active (kW) | Dimensions W x D x H (mm) | Weight (kg) |
| 3 111 00 | 10 | 9 | 260 x 850 x 890 | 74 |
| 3 111 01 | 10 | 9 | 260 x 850 x 890 | 149 |
| 3 111 02 | 15 | 13.5 | 260 x 850 x 890 | 76 |
| 3 111 03 | 15 | 13.5 | 260 x 850 x 890 | 166 |
| 3 111 04 | 20 | 18 | 260 x 850 x 890 | 76 |
| 3 111 05 | 20 | 18 | 260 x 850 x 890 | 176 |

Accessories

| | Description | Dimensions W x D x H (mm) |
|-----------------|-------------------------------------|---------------------------|
| 3 110 94 | Empty Keor Compact battery cabinet | 260 x 850 x 890 |
| 3 110 95 | Keor Compact battery cabinet 10 kVA | 260 x 850 x 890 |
| 3 110 96 | Keor Compact battery cabinet 15 kVA | 260 x 850 x 890 |
| 3 110 97 | Keor Compact battery cabinet 20 kVA | 260 x 850 x 890 |
| 3 110 98 | Parallel system kit | |
| 3 110 99 | RS-485 MODBUS card | |
| 3 111 06 | Dry contact card | |
| 3 110 86 | Battery temperature probe | |

Backup times table

| | Power (kVA) | Back-up time (min) | No. of battery cabinets* |
|----------------------------|-------------|--------------------|--------------------------|
| 311101 | 10 | 11 | 0 |
| 311101 + 1 x 311095 | 10 | 50 | 1 |
| 311101 + 2 x 311095 | 10 | 87 | 2 |
| 311101 + 3 x 311095 | 10 | 126 | 3 |
| 311103 | 15 | 7 | 0 |
| 311103 + 1 x 311096 | 15 | 40 | 1 |
| 311103 + 2 x 311096 | 15 | 67 | 2 |
| 311103 + 3 x 311096 | 15 | 99 | 3 |
| 311105 | 20 | 6 | 0 |
| 311105 + 1 x 311097 | 20 | 28 | 1 |
| 311105 + 2 x 311097 | 20 | 57 | 2 |
| 311105 + 3 x 311097 | 20 | 81 | 3 |

* 0 = UPS with internal batteries only.

Dimensions (mm)

Keor Compact 10 - 15 - 20 kVA

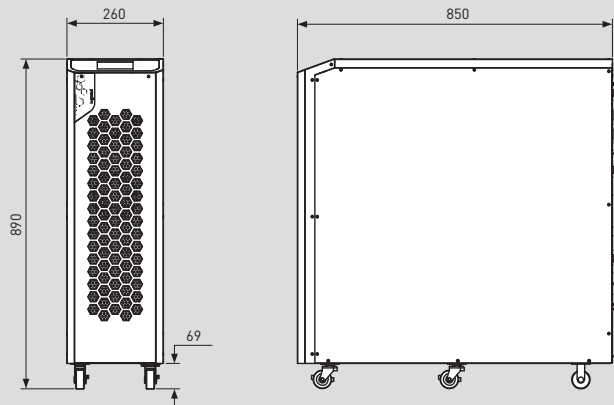

Battery cabinet

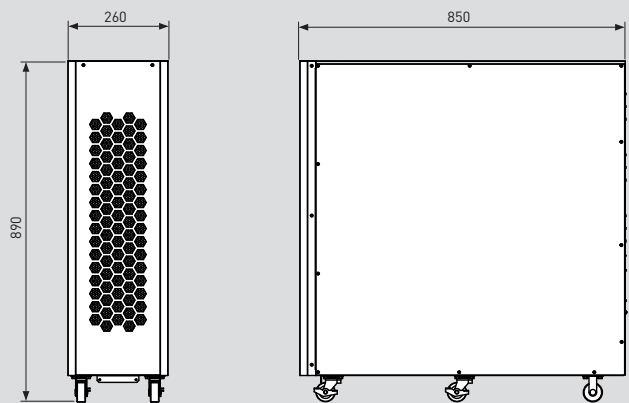

NOTE: the stated backup times in minutes are estimated and may vary according to the load characteristics, operating conditions and environment.

For the choice of communication accessories, see the dedicated section of this catalogue.

Keor Compact

Conventional UPS - On-line three-phase double conversion VFI

| ■ Characteristics | | | |
|---|--|-----------------|-----------------|
| General Characteristics | Keor Compact 10 | Keor Compact 15 | Keor Compact 20 |
| Nominal power (kVA) | 10 | 15 | 20 |
| Active power (kW) | 9 | 13.5 | 18 |
| Technology | On-Line Double Conversion VFI-SS-111 | | |
| Waveform | Sinusoidal | | |
| Architecture | Stand Alone or Distributed with parallelable system with up to 6 units | | |
| Efficiency | up to 95% | | |
| Efficiency in ECO mode | up to 98.5% | | |
| Input | | | |
| Nominal input voltage | 400V (3Ph+N+PE) | | |
| Nominal voltage (Ph-Ph) | ±20% @100% load, -40/+20% @50% load | | |
| Input frequency | 40-70 Hz | | |
| THD Input current | <3% at full load | | |
| Dual Input | yes | | |
| Compatibility with Power Supply Units | yes | | |
| Input Power Factor | >0.99 | | |
| Output | | | |
| Output voltage | 380, 400, 415V (3Ph+N+PE) | | |
| Output voltage tolerance | ± 1% static load | | |
| Nominal output frequency | 50 /60 Hz (Adjustable from the front panel) | | |
| Output frequency tolerance | ± 1 Hz / ± 3 Hz adjustable synch Mains for Bypass; ± 0.01% Free Run | | |
| Peak factor | 3:1 | | |
| THD Output voltage | <2% (with linear load), <5% (with non-linear load) | | |
| Output power factor | 0.9 | | |
| Overload capacity | 60 min at 110%, 10 min at 125%; 1 min at 150% | | |
| Bypass | Automatic and maintenance bypass | | |
| Batteries | | | |
| Cold Start | yes | | |
| Battery Type | VRLA | | |
| Internal batteries | yes | | |
| Communication and management | | | |
| Display | 4.3" colour touch-screen display. | | |
| Communication ports | RS232, Genset, 4 programmable relay contacts, RS485 (optional), network interface slot | | |
| Backfeed protection | Integrated | | |
| Alarms and signals | Alarms and audible warnings | | |
| Emergency Power Off (EPO) | yes | | |
| Remote control | available | | |
| Mechanical characteristics | | | |
| Ventilation | Forced with fan from the front to the rear | | |
| Maximum heat dissipation (100% of the W load, battery recharging) | 600 | 900 | 1300 |
| Colour | RAL9017 (black-cabinet) RAL9003 (white - control panel) | | |
| Dimensions W x D x H (mm) | 260 x 850 x 890 | | |
| Weight (without battery) (kg) | 74 | 76 | 76 |
| Weight (with batteries) (kg) | 149 | 166 | 176 |
| Ambient Conditions | | | |
| Operating temperature (°C) | 0 - 40°C (recommended temperature for longer useful battery life: 20-25°C) | | |
| Relative humidity | 20-95% (not condensing) | | |
| Protection rating | IP20 | | |
| Noise at 1 m from the unit (dBA) | < 52 | | |
| Estimated content of circular economy derived materials | ≈ 39% | | |
| Recyclability rate calculated using the method described in technical report IEC/TR 62635* | ≈ 71% | | |
| Conformity | | | |
| Certifications | IEC/EN 62040-1, IEC/EN 62040-2, IEC/EN 62040-3 | | |

*This value is based on data collected from a technological channel operating on an industrial basis. It does not pre-validate the effective use of this channel for end-of-life of this product.

Keor T Evo

UPS - On-line three-phase double conversion VFI



Keor T Evo 10-30

Keor T Evo 10-30

Keor T Evo 40-60

Characteristics:

- Output from 10 to 60 kVA
- New Keor T Eco up to 20 kVA and power factor 1
- Three-phase UPS
- 3 level Switching technology
- IGBT Rectifier and inverter
- High efficiency
- Digital signal processor (DSP)
- High Input Power Factor Correction
- 3.5" TFT touch screen panel
- High output Power Factor
- Low input and output total harmonic distortion values (THD)
- Compatibility with gensets
- Parallelable system with up to 4 units
- Communication ports

| Item | UPS | Nominal power (kVA) | Back-up time (min.) | Dimensions (mm) | Weight (kg) |
|----------|-----|---------------------|---------------------|------------------|-------------|
| 3 110 20 | | 10 | 0 | 1345 x 400 x 800 | 122 |
| 3 110 21 | | 10 | 24 | 1345 x 400 x 800 | 261 |
| 3 110 22 | | 10 | 37 | 1345 x 400 x 800 | 283 |
| 3 110 23 | | 10 | 57 | 1650 x 400 x 800 | 426 |
| 3 110 24 | | 15 | 0 | 1345 x 400 x 800 | 127 |
| 3 110 25 | | 15 | 14 | 1345 x 400 x 800 | 268 |
| 3 110 26 | | 15 | 22 | 1345 x 400 x 800 | 288 |
| 3 110 27 | | 15 | 33 | 1650 x 400 x 800 | 431 |
| 3 110 28 | | 20 | 0 | 1345 x 400 x 800 | 134 |
| 3 110 29 | | 20 | 10 | 1345 x 400 x 800 | 275 |
| 3 110 30 | | 20 | 15 | 1345 x 400 x 800 | 296 |
| 3 110 31 | | 20 | 37 | 1650 x 400 x 800 | 477 |
| 3 110 32 | | 30 | 0 | 1345 x 400 x 800 | 141 |
| 3 110 33 | | 30 | 10 | 1345 x 400 x 800 | 302 |
| 3 110 34 | | 30 | 13 | 1650 x 400 x 800 | 441 |
| 3 110 35 | | 30 | 22 | 1650 x 400 x 800 | 484 |
| 3 110 36 | | 40 | 0 | 1650 x 600 x 900 | 238 |
| 3 110 37 | | 40 | 10 | 1650 x 600 x 900 | 538 |
| 3 110 38 | | 40 | 15 | 1650 x 600 x 900 | 573 |
| 3 110 39 | | 40 | 25 | 1650 x 600 x 900 | 740 |
| 3 110 40 | | 60 | 0 | 1650 x 600 x 900 | 258 |
| 3 110 41 | | 60 | 10 | 1650 x 600 x 900 | 590 |
| 3 110 42 | | 60 | 15 | 1650 x 600 x 900 | 755 |

NOTE: the stated backup times in minutes are estimated and may vary according to the load characteristics, operating conditions and environment.

Keor T Evo 10-15-20-30-40-60 with internal batteries

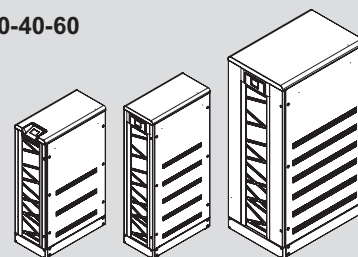

Keor T Evo 10-15-20-30 with external battery cabinet

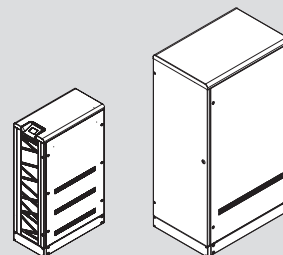

Keor T Evo 40-60 with external battery cabinet

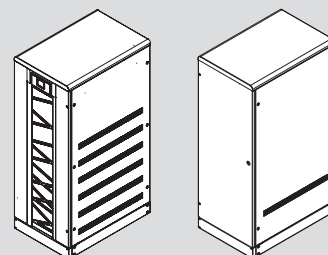

| Item | Keor T 208 V | Nominal power (kVA) | Active Power (kW) | Dimensions H x W x D (mm) | Net weight (kg) |
|----------|--------------|---------------------|-------------------|---------------------------|-----------------|
| 3 101 32 | | 5 | 4,5 | 1345 x 400 x 800 | 118 |
| 3 101 33 | | 7,5 | 6,75 | 1345 x 400 x 800 | 132 |
| 3 101 34 | | 10 | 9 | 1345 x 400 x 800 | 134 |
| 3 102 78 | | 15 | 13,5 | 1345 x 400 x 800 | 140 |
| 3 102 79 | | 20 | 18 | 1650 x 600 x 900 | 255 |
| 3 102 96 | | 30 | 27 | 1650 x 600 x 900 | 277 |
| 3 102 97 | | 40 | 36 | 1650 x 600 x 800 | 315 |
| 3 102 98 | | 50 | 45 | 1650 x 600 x 800 | 350 |
| 3 102 99 | | 60 | 54 | 1650 x 793 x 800 | 430 |

Accessories

- 3 109 18 Battery cabinet empty (up to 60 blocks 55 Ah)
- 3 109 21 Internal cables kit for battery cabinet empty (for 60 blocks 55 Ah)
- 3 109 11 Battery drawers kit for Keor T Evo 10-30 kVA (up to 60 blocks 7-9 Ah)
- 3 109 12 Battery drawers kit for Keor T Evo 40-60 kVA (up to 60 blocks 7-9 Ah)
- 3 109 13 Internal battery cables kit for battery drawers Keor T Evo 10-30 kVA
- 3 109 14 Internal battery cables kit for battery drawers Keor T Evo 40-60 kVA
- 3 109 16 Kit for both in & ext battery connections for 1345H*
- 3 109 15 Parallel kit/UPS (PCB + 5 m cable)*
- 3 110 46 Parallel connection cable
- 3 110 47 Temperature Probe
- 3 109 87 Keor T Evo Battery Cabinet A
- 3 109 88 Keor T Evo Battery Cabinet B**

* Needed Only for 208 V version

** To be used in multiples of 2.



For the choice of communication accessories, see the dedicated section of this catalogue.

Keor T Evo

UPS - On-line three-phase double conversion VFI

| ■ Characteristics | | | | | | | | | |
|---|--|-----------------|----------------|------------------|----------------|------------------|----------------|------------------|----------------|
| Model 3Ph 400V (380-400-415V) 3Ph | Keor T Evo 10 | Keor T Evo 15 | Keor T Evo 20 | Keor T Evo 30 | Keor T Evo 40 | Keor T Evo 60 | | | |
| Nominal power (kVA) | 10 | 15 | 20 | 30 | 40 | 60 | | | |
| Active power (kW) | 10 | 15 | 20 | 30 | 40 | 60 | | | |
| 3Ph version 208V (200-208-220V) | Keor T 208V 5 | Keor T 208V 7,5 | Keor T 208V 10 | Keor T 208V 15 | Keor T 208V 20 | Keor T 208V 30 | Keor T 208V 40 | Keor T 208V 50 | Keor T 208V 60 |
| Nominal power (kVA) | 5 | 7,5 | 10 | 15 | 20 | 30 | 40 | 50 | 60 |
| Active power (kW) | 4,5 | 6,75 | 9 | 13,5 | 18 | 27 | 36 | 45 | 54 |
| General characteristics | | | | | | | | | |
| Technology | On-line double conversion VFI-SS-111 | | | | | | | | |
| Waveform | Sinusoidal | | | | | | | | |
| Architecture | Stand alone or distributed parallel up to 6 units | | | | | | | | |
| Input Characteristics | | | | | | | | | |
| Input voltage | 400V (3Ph+N+PE)* / 200-208-220V (3Ph+N+PE)** | | | | | | | | |
| Input frequency | 45-65 Hz | | | | | | | | |
| Input voltage range (Ph-Ph) | ±20%* / ±15%** | | | | | | | | |
| THD of input current | <5% at full load | | | | | | | | |
| Compatibility with diesel generators | Yes | | | | | | | | |
| Input power factor | >0.99 | | | | | | | | |
| Output characteristics | | | | | | | | | |
| Output voltage | 380, 400, 415V (3Ph+N+PE)* / 200-208-220V (3Ph+N+PE)** (Adjustable from front panel) | | | | | | | | |
| Efficiency | up to 96% * | | | | | | | | |
| Efficiency in ECO mode | up to 98,5% | | | | | | | | |
| Output frequency (nominal) | 50 /60 Hz (Adjustable from front panel) | | | | | | | | |
| Output frequency tolerance | ±0,1%Synch with Mains; ±0,01% Free Run | | | | | | | | |
| Crest factor | up to 3:1 | | | | | | | | |
| THD of output voltage | < 2% at full linear load | | | | | | | | |
| Output power factor | 1* / 0,9** | | | | | | | | |
| Output voltage tolerance | ± 1% | | | | | | | | |
| Overload capability | 10 min at 125%; 60 sec at 150% | | | | | | | | |
| By-pass | Builtin automatic and maintenance bypass | | | | | | | | |
| Batteries | | | | | | | | | |
| Battery type | VRLA – AGM Maintenance free | | | | | | | | |
| Internal batteries | Yes | | | | No | | | | |
| Battery test | Yes Automatic or Manual | | | | | | | | |
| Battery recharge profile | IU (DIN41773) | | | | | | | | |
| Communication and management | | | | | | | | | |
| LCD Display | Touch screen, led bar status, live synoptic view for real time | | | | | | | | |
| Communication Ports | RS232, RS485, GenSet, Programmable 4 relay contacts, ModBus | | | | | | | | |
| Back feed protection | Internal back feed protection device is standard | | | | | | | | |
| Audible alarm | Acoustic alarms and warnings | | | | | | | | |
| Net interface slot | optional SNMP card | | | | | | | | |
| Emergency Power Off (EPO) | Yes | | | | | | | | |
| Remote management | Available | | | | | | | | |
| Physical characteristics | | | | | | | | | |
| Dimensions H x W x D (mm) | 1345/1650 x 400 x 800* | | | 1650 x 600 x 900 | | 1650 x 600 x 980 | | 1650 x 793 x 800 | |
| Dimensions battery cabinet H x W x D (mm) | 1650 x 800 x 900 | | | | | | | | |
| Ambient conditions | | | | | | | | | |
| Operating temperature (°C) | 0-40 | | | | | | | | |
| Relative humidity (%) | 20-95% not condensing | | | | | | | | |
| Protection index | IP20 | | | | | | | | |
| Noise at 1 m (dBA) | < 58 | | | < 60 | | | < 65 | | |
| Estimated content of circular economy derived materials | 39% | | | | | | | | |
| Recyclability rate calculated using the method described in technical report IEC/TR 62635*** | 71% | | | | | | | | |
| Compliance | | | | | | | | | |
| Reference product standards | EN 62040-1, EN 62040-2, EN 62040-3 | | | | | | | | |

* for 3Ph 400V Version
 ** for 3Ph 208V Version

*** This value is based on data collected from a technological channel operating on an industrial basis. It does not pre-validate the effective use of this channel for end-of-life of this product.

Keor HP

Conventional UPS - On-line three-phase double conversion VFI



Keor HP 100



Keor HP 400

Characteristics:

- Power from 100 to 800 kVA
- Three-phase UPS
- Rectifier IGBT
- High efficiency
- Digital signal processor (DSP)
- High Input Power Factor Correction
- High output Power Factor
- Battery recharge with temperature compensation
- Output isolation transformer
- Low input and output total harmonic distortion values (THD)
- Compatibility with gensets
- Parallelable system with up to 6 units
- Communication ports
- Optimised cooling system

| Model | UPS (without batteries) | | | |
|--------------------|-------------------------|-----------------|---------------------------|-----------------|
| | Power nominal kVA | Active power kW | Dimensions H x W x D (mm) | Net weight (kg) |
| Keor HP 100 | 100 | 90 | 1670 x 815 x 825 | 625 |
| Keor HP 125 | 125 | 112.5 | 1670 x 815 x 825 | 660 |
| Keor HP 160 | 160 | 144 | 1670 x 815 x 825 | 715 |
| Keor HP 200 | 200 | 180 | 1905 x 1220 x 870 | 970 |
| Keor HP 250 | 250 | 225 | 1905 x 1220 x 870 | 1090 |
| Keor HP 300 | 300 | 270 | 1905 x 1220 x 870 | 1170 |
| Keor HP 400 | 400 | 360 | 1920 x 1990 x 965 | 1820 |
| Keor HP 500 | 500 | 450 | 2020 x 2440 x 950 | 2220 |
| Keor HP 600 | 600 | 540 | 2020 x 2440 x 950 | 2400 |
| Keor HP 800 | 800 | 720 | 1920 x 3640 x 950 | 3600 |

Accessories

3 109 89

Keo HP battery cabinet full*

Empty battery cabinet with connections and protections
10 year batteries in cabinets

(1)

Isolation transformer
External bypass
Remote control panel

(1) Attachments to be defined during the order phase.

* to be used in multiples of 2



For the choice of communication accessories, see the dedicated section of this catalogue.

Keor HP 100-125-160

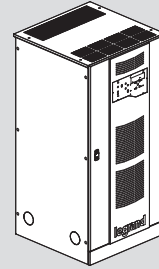

Keor HP 200-250-300

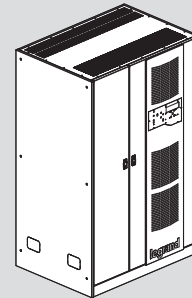

Keor HP 400

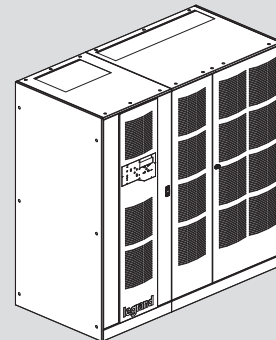

Keor HP 500-600

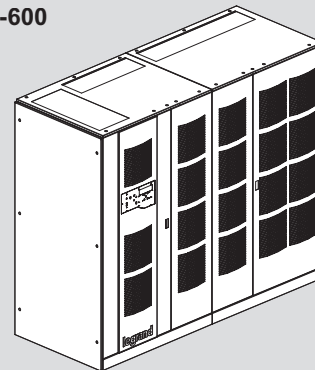

Keor HP 800

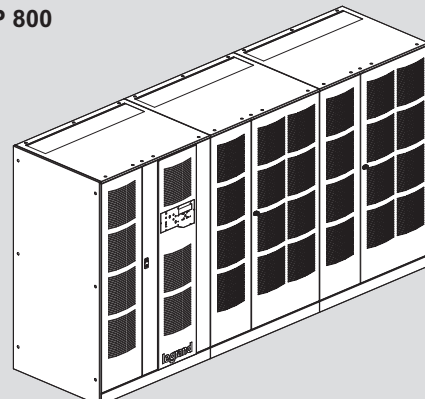

Keor HP

Conventional UPS - On-line three-phase double conversion VFI

| Characteristics | | | | | | | | | | |
|---|---|-------|-----|---|------|--|-----------------------------------|-------------------|-------------------|-------------------|
| General Characteristics | 100 | 125 | 160 | 200 | 250 | 300 | 400 | 500 | 600 | 800 |
| Nominal power (VA) | 100 | 125 | 160 | 200 | 250 | 300 | 400 | 500 | 600 | 800 |
| Active power (W) | 90 | 112.5 | 144 | 180 | 225 | 270 | 360 | 450 | 540 | 720 |
| Technology | On-Line Double Conversion VFI-SS-111 | | | | | | | | | |
| Waveform | Sinusoidal | | | | | | | | | |
| UPS Architecture | Conventional UPS parallel operations with up to 6 units | | | | | | | | | |
| Input | | | | | | | | | | |
| Input voltage | 400V -20% / +15% 3Ph+N | | | | | | | | | |
| Input frequency | 50-60 Hz ± 10% autosensing | | | | | | | | | |
| THD Input current | <3% | | | | | | | | | |
| Compatibility with genset | Configurable to achieve synchronisation between the input frequencies and output frequencies, also for wider frequency ranges | | | | | | | | | |
| Input power factor | >0.99 | | | | | | | | | |
| Output | | | | | | | | | | |
| Output voltage | 380, 400, 415 V 3Ph+N selectable | | | | | | | | | |
| Efficiency | Up to 95% | | | | | | | | | |
| Output frequency (nominal) | 50 /60 Hz selectable ± 0,001% | | | | | | | | | |
| Peak factor | 3:1 | | | | | | | | | |
| THD of Output voltage | <5% (with non-linear load) | | | | | | | | | |
| Output voltage tolerance | ± 1% (with balanced load) | | | | | | | | | |
| Overload capacity | 10 minutes at 125%, 1 minute at 150%, 10 seconds at 200% | | | | | | | | | |
| Efficiency in Eco Mode | 98% | | | | | >98% | | | | |
| Bypass | Automatic and maintenance bypass | | | | | Automatic bypass (optional maintenance bypass) | | | | |
| Batteries | | | | | | | | | | |
| Backup time extension | Yes with additional battery cabinets | | | | | | | | | |
| Battery series type/voltage | VRLA- AGM Lead Acid, sealed, maintenance-free | | | | | | | | | |
| Battery test | Automatic or manual | | | | | | | | | |
| Battery charger | IU (DIN41773) | | | | | | | | | |
| Communication and management | | | | | | | | | | |
| LCD Display | LCD and LED display to monitor UPS status in real-time 4 menu navigation buttons | | | | | | | | | |
| Communication ports | RS232, network interface slot or floating contact card, RS485 (optional) | | | | | | | | | |
| Alarms and signals | Configurable audible alarms and warnings | | | | | | | | | |
| Configuration settings | By expert operators, self-configurable firmware | | | | | | | | | |
| Emergency Power Off (EPO) | Yes | | | | | | | | | |
| Remote control | Available | | | | | | | | | |
| Battery temperature sensor | Yes | | | | | | | | | |
| Mechanical characteristics | | | | | | | | | | |
| Dimensions (HxWxD) (mm) | 1670 x 815 x 825 | | | 1905 x 1220 x 855 | | | 1920 x 1990 x 965 | 2020 x 2440 x 950 | 2020 x 2440 x 950 | 1920 x 3640 x 950 |
| Net weight (kg) | 625 | 660 | 715 | 970 | 1090 | 1170 | 1820 | 2220 | 2400 | 3600 |
| Battery cabinet dimensions (H x W x D) (mm) | 1900x1400x830 (50 batteries) 1900x2800x830 (100 batteries) | | | 1900x1400x860 (50 batteries) 1900x2800x860 (100 batteries) | | | 1900 x 2800 x 860 (100 batteries) | | | |
| Ambient conditions | | | | | | | | | | |
| Operating temperature (°C) | 0 – 40 | | | | | | | | | |
| Relative humidity (%) | <95% non condensing | | | | | | | | | |
| Protection rating | IP20 | | | | | | | | | |
| Noise at 1 m from the unit (dBA) | < 60 | | | | | < 62 | | | | |
| Estimated content of circular economy derived materials | 11% | | | | | | | | | |
| Recyclability rate calculated using the method described in technical report IEC/TR 62635* | 69% | | | | | | | | | |
| Conformity | | | | | | | | | | |
| Certifications | EN 62040-1, EN 62040-2, EN 62040-3 | | | | | | | | | |

*This value is based on data collected from a technological channel operating on an industrial basis. It does not pre-validate the effective use of this channel for end-of-life of this product.

Keor HPE

Conventional UPS - On-line three-phase double conversion VFI



Characteristics:

- Power from 60 to 500 kVA
- Three-phase UPS
- IGBT Rectifier
- High efficiency
- Digital signal processor (DSP)
- High Input Power Factor Correction (PFC)
- Output Power Factor 1
- Battery recharge, dynamic, intermittent with temperature compensation
- Low input and output total harmonic distortion values (THD)
- Compatibility with gensets
- Parallel operations with up to 6 units
- Communication ports
- Optimised cooling system

| Model | UPS | | Back-up time (min) | Dimensions H x W x D (mm) | Net weight (kg) |
|-----------------|---------------------|-------------------|--------------------|---------------------------|-----------------|
| | Nominal power (kVA) | Active power (kW) | | | |
| 3 110 87 | 60 | 60 | 0 | 1500 x 560 x 940 | 225 |
| 3 110 88 | 60 | 60 | 5 | 1500 x 560 x 940 | 525 |
| 3 110 89 | 60 | 60 | 10 | 1500 x 560 x 940 | 675 |
| 3 110 90 | 80 | 80 | 0 | 1500 x 560 x 940 | 250 |
| 3 110 91 | 80 | 80 | 5 | 1500 x 560 x 940 | 700 |
| 9 605 69 | 100 | 100 | - | 1800 x 560 x 940 | 320 |
| 9 605 70 | 125 | 125 | - | 1800 x 560 x 940 | 360 |
| 9 605 71 | 160 | 160 | - | 1800 x 560 x 940 | 380 |
| 9 605 72 | 200 | 200 | - | 1978 x 880 x 970 | 720 |
| 9 535 00 | 250 | 250 | - | 1978 x 880 x 970 | 850 |
| 9 535 01 | 300 | 300 | - | 1978 x 880 x 970 | 900 |
| 9 535 02 | 400 | 400 | - | 1978 x 1430 x 970 | 1080 |
| 9 535 03 | 500 | 500 | - | 1978 x 1430 x 970 | 1250 |

Accessories

- 9 535 16** Parallel interface
- 9 535 17** Interface for MODBUS RS485
- 3 109 87** Keor HPE Full Battery Cabinet
- 3 109 88** Keor HPE Full Battery Cabinet*
- Empty battery cabinets

Options

- Consult us** Synchronism kit on two UPS**
- Synchronism kit on two parallel UPS**
- Isolation transformer
- 7" touch display (for Keor HPE 60-160)
- IP 21 Kit
- Common battery kits



* to be used in multiples of 2

** to create two independent synchronous electrical lines (typical in Tier III, IV systems)

NOTE: the stated backup times in minutes are estimated and may vary according to the load characteristics, operating conditions and environment.

For the choice of communication accessories, see the dedicated section of this catalogue.

Keor HPE 60-80 kVA

Keor HPE 100-125-160 kVA

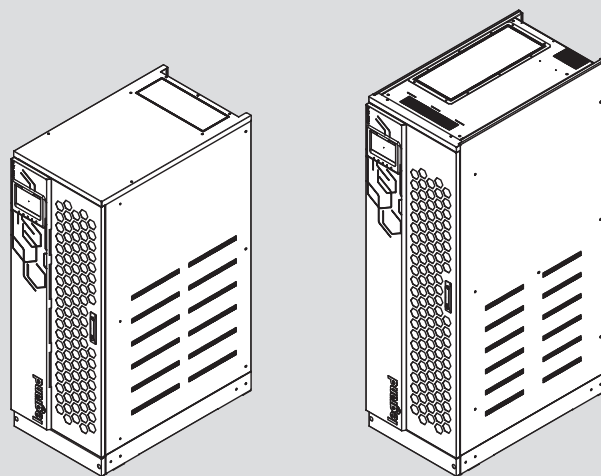

Keor HPE 200-250-300 kVA

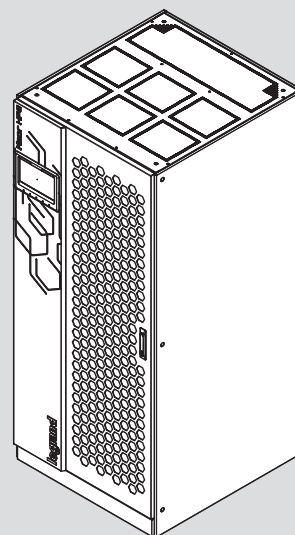

Keor HPE 400-500 kVA

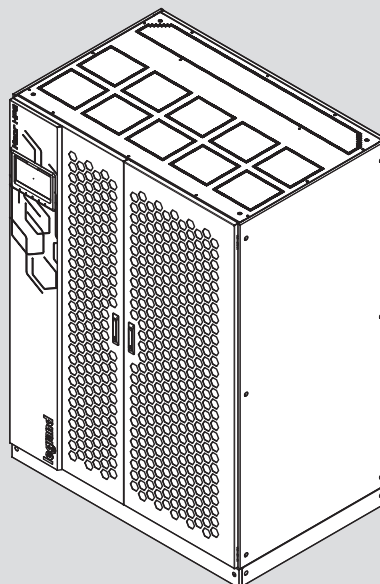

Keor HPE

Conventional UPS - On-line three-phase double conversion VFI

Characteristics

| General Characteristics | 60 | 80 | 100 | 125 | 160 | 200 | 250 | 300 | 400 | 500 | |
|---|---|-----------|-----|------------------|-----|--|------------------|-----|--------|-------------------|--|
| Nominal power (kVA) | 60 | 80 | 100 | 125 | 160 | 200 | 250 | 300 | 400 | 500 | |
| Active power (kW) | 60 | 80 | 100 | 125 | 160 | 200 | 250 | 300 | 400 | 500 | |
| Technology | On-Line Double Conversion VFI-SS-111 | | | | | | | | | | |
| Waveform | Sinusoidal | | | | | | | | | | |
| UPS Architecture | Conventional UPS parallel operations with up to 6 units | | | | | | | | | | |
| Input | | | | | | | | | | | |
| Input voltage | 380-400-415 V 3Ph+N | | | | | | | | | | |
| Input frequency | 50-60 Hz (45÷65Hz) | | | | | | | | | | |
| Input voltage range | 400 V -20% / + 15% | | | | | | | | | | |
| THD Input current | < 3% | | | | | | | | | | |
| Compatibility with genset | Configurable to achieve synchronisation between the input frequencies and output frequencies, also for wider frequency ranges | | | | | | | | | | |
| Input power factor | > 0.99 | | | | | | | | | | |
| Output | | | | | | | | | | | |
| Output voltage | 380, 400, 415 V 3Ph+N | | | | | | | | | | |
| Efficiency | Up to 95% | Up to 96% | | | | | Up to 96.4% | | | | |
| Nominal output frequency | 50 /60 Hz | | | | | | | | | | |
| Peak factor | 3:1 | | | | | | | | | | |
| THD of Output voltage | <1% (with linear load) <5% (with non-linear load) | | | | | | | | | | |
| Output voltage tolerance | ± 1% (with balanced load) | | | | | | | | | | |
| Overload capacity | 10 minutes at 125%, 30 seconds at 150% 0,1 seconds >150% | | | | | 10 minutes at 110%, 5 minutes at 125%, 30 seconds at 150% 0.1 seconds >150% | | | | | |
| Efficiency in Eco Mode | > 98% | | | | | | | | | | |
| Bypass | Automatic and maintenance bypass | | | | | | | | | | |
| Batteries | | | | | | | | | | | |
| Internal batteries | yes | yes | - | - | - | - | - | - | - | - | |
| Backup time extension | Yes with additional battery cabinets | | | | | | | | | | |
| Battery series type | VRLA- AGM Lead Acid, sealed, maintenance-free | | | | | | | | | | |
| Battery test | Automatic or manual | | | | | | | | | | |
| Battery charger | IU (DIN41773) | | | | | | | | | | |
| Communication and management | | | | | | | | | | | |
| LCD Display | LCD and LED display to monitor UPS status in real-time 4 menu navigation buttons (optional 7" touch screen) | | | | | 10" touch screen display to monitor UPS status in real-time | | | | | |
| Communication ports | relay contact card, RS232, USB, RS485 (optional), network interface slot | | | | | | | | | | |
| Alarms and signals | Configurable audible alarms and warnings | | | | | | | | | | |
| Emergency Power Off (EPO) | yes | | | | | | | | | | |
| Remote control | available | | | | | | | | | | |
| Battery temperature sensor | yes | | | | | | | | | | |
| Mechanical characteristics | | | | | | | | | | | |
| Dimensions (HxWxD) (mm) | 1500 x 560 x 940 | | | 1800 x 560 x 940 | | | 1978 x 880 x 970 | | | 1978 x 1430 x 970 | |
| Net weight (kg) | 225 | 250 | 320 | 360 | 380 | 720 | 850 | 900 | 1080 | 1250 | |
| Ambient conditions | | | | | | | | | | | |
| Operating temperature (°C) | 0 – 40 | | | | | | | | | | |
| Relative humidity (%) | < 95% non condensing | | | | | | | | | | |
| Protection rating | IP20 | | | | | | | | | | |
| Noise at 1 m from the unit (dBA) | < 60 | | | | | < 65 | | | < 72dB | | |
| Estimated content of circular economy derived materials | 17% | | | | | | | | | | |
| Recyclability rate calculated using the method described in technical report IEC/TR 62635* | 56% | | | | | | | | | | |
| Conformity | | | | | | | | | | | |
| Certifications | EN 62040-1, EN 62040-2, EN 62040-3 | | | | | | | | | | |

*This value is based on data collected from a technological channel operating on an industrial basis. It does not pre-validate the effective use of this channel for end-of-life of this product.

Keor XPE

Scalable UPS - Online three-phase double conversion VFI



In/Out-Bypass Module



Power unit
Up to 7 units



Distribution cabinet
(optional)

Characteristics

- On-Line Double Conversion VFI SS 111
- 3-level IGBT technology - Transformer Free
- Output power factor = 1 without downgrading up to 40°C in continuous operation mode (VFI)
- Configurable internal redundancy (N + 1 or N + X).
- Hot maintainable modules
- Hot scalability (optional)
- Up to 96,4% efficiency VFI even at low power
- ECO mode up to 99% of efficiency.
- Built-in backfeed protection
- Automatic battery test feature.
- Genset compatibility with Adaptive Ramp-in
- Compact design.
- Low audible noise.
- Synch 2N

| Components | UPS | | Dimensions HxWxD (mm) |
|------------------------------|------------------|------|--------------------------|
| POWER UNIT | 250 | 250 | 880x979x2100 |
| POWER UNIT | 300 | 300 | 880x979x2100 |
| IOBM 600 | 600 | 600 | 1002x979x2100 |
| IOBM 750 | 750 | 750 | 1450x979x2100 |
| IOBM 900-1000 | 1000 | 1000 | 1500x979x2100 |
| IOBM 1200-1500 | 1500 | 1500 | 1850x1000x2100 |
| IOBM 1800-2100 | 2100 | 2100 | 2300x1200x2100 |
| DISTRIBUTION CABINET* | 2 x 300 kW lines | | 800x979x2100 |
| DISTRIBUTION CABINET* | 3 x 300 kW lines | | 800x979x2100 |
| DISTRIBUTION CABINET* | 4 x 300 kW lines | | 800x979x2100 |
| DISTRIBUTION CABINET* | 5 x 300 kW lines | | 800x979x2100 |

* for hot-swapping

Options

Consult us

- Description
- Future Scalability
 - Hot Scalability
 - Input Line: Dual/Single
 - Connection Entrance: Bottom/Top
 - Connection Type: Cable/Busbar
 - Grounding System: TNC/TNS
 - Icw limitation kit
 - Battery set: Centralized/Distributed
 - Central or side IOBM
 - Special distribution kits for customised cabinet layouts
 - IP21 Kit

Accessories

Consult us

- Description
- Battery cabinets
 - Battery switch fuse box
 - Synchronisation box
 - MODBUS RS485 card
 - Ethernet card with network interface

Please contact Legrand for further details on the configurations and accessories.

Dimensions

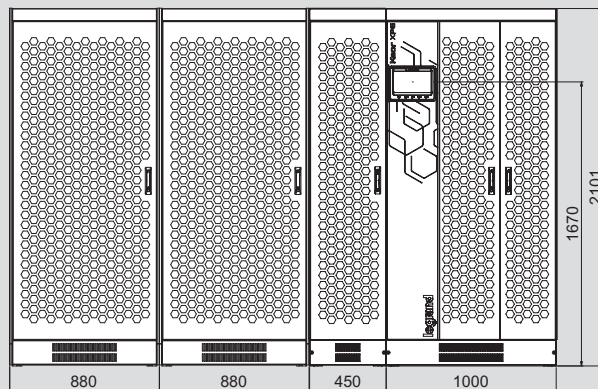
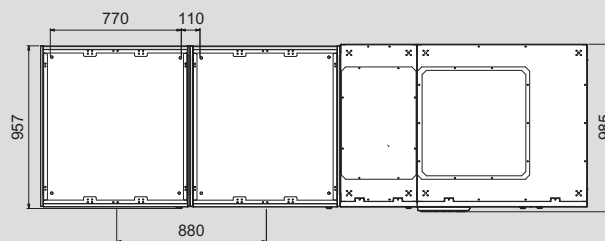

Keor XPE

Scalable UPS - Online three-phase double conversion VFI

| Characteristics | | | | | | | | | |
|---|--|---------------|---------------|---------------|---------------|----------------|----------------|-----------|-----------|
| General Characteristics | IOBM 600 | IOBM 750 | IOBM 900 | IOBM 1000 | IOBM 1200 | IOBM 1250 | IOBM 1500 | IOBM 1800 | IOBM 2100 |
| Nominal power (kVA) | 600 | 750 | 900 | 1000 | 1200 | 1250 | 1500 | 1800 | 2100 |
| Power Unit power (kVA) | 300 | 250 | 300 | 250 | 300 | 250 | 300 | 300 | 300 |
| Number of power units (+1 redundant) | 2+1 | 3+1 | 3+1 | 4+1 | 4+1 | 5+1 | 5+1 | 6+1 | 7 |
| Technology | On-Line Double Conversion VFI-SS-111 | | | | | | | | |
| Architecture | Decentralised logic, centralised static bypass, scalable, redundant, hot-swap service (optional hot plug) | | | | | | | | |
| Input | | | | | | | | | |
| Input voltage | 400 Vac three-phase (rectifier), 380/400/415 Vac three-phase (Bypass) | | | | | | | | |
| Input frequency | 50/60 Hz; range 45-65 Hz | | | | | | | | |
| Input Voltage Range (Ph-Ph) | -20%, +15% (rectifier); ±10% (bypass) | | | | | | | | |
| THD Input current | < 3% | | | | | | | | |
| Compatibility with genset | Yes | | | | | | | | |
| Input power factor | > 0.99 | | | | | | | | |
| Output | | | | | | | | | |
| Output voltage | 380, 400, 415V (3Ph+N+PE) | | | | | | | | |
| Online Efficiency | up to 96.4% | | | | | | | | |
| Efficiency in GREEN Mode | up to 99% | | | | | | | | |
| Nominal output frequency | 50 /60 Hz (Adjustable from the front panel) | | | | | | | | |
| Peak factor | up to 3:1 | | | | | | | | |
| THD of Output voltage | < 1% with linear load | | | | | | | | |
| Output Power Factor | 0.7 which reaches 0.5 in delay without downgrading | | | | | | | | |
| Output voltage adjustment VFI | Static ± 1%; Dynamic Class 1 IEC/EN 62040-3 | | | | | | | | |
| Overload capacity | Inverter: 125% for 5 min, 150% for 30 sec; | | | | | | | | |
| Bypass | | | | | | | | | |
| Type | Automatic static without interruption, manual bypass optional | | | | | | | | |
| Input voltage | 380-400-415V ± 20%; (3Ph+N+PE) | | | | | | | | |
| Input frequency | 50-60Hz ± 10% | | | | | | | | |
| Rated current (A) | 870 | 1090 | 1304 | 1450 | 1739 | 1810 | 2175 | 2609 | 3044 |
| Max. LCW | 50 kA IEC 62040-1 standard (100 kA optional) | | | | | | | | |
| Batteries | | | | | | | | | |
| Battery type | VRLA, NiCd, Li-Ion | | | | | | | | |
| Connecting the battery | Distributed or centralised | | | | | | | | |
| Communication and management | | | | | | | | | |
| LCD Display | 10" Touch screen, 1024x600 pixels | | | | | | | | |
| Communication ports | RS232, USB, RS485, network interface slot | | | | | | | | |
| Input and auxiliary contact signal ports. | Remote Emergency Power Off (REPO), diesel mode, temperature probe, battery circuit breaker. External automatic switch auxiliary contact: battery, external maintenance bypass, remote output transfer in bypass mode | | | | | | | | |
| Output signal ports | 5 dry contacts, external BackFeed | | | | | | | | |
| Mechanical characteristics | | | | | | | | | |
| Connection lines | Wired TNC or TNS 3PH output, rectifier and bypass (single input optional) | | | | | | | | |
| Input and connection type | Bottom (top as optional), cable (busbar as optional) | | | | | | | | |
| Colour | RAL 9003 (white) on the front panel of the IOBM; RAL 9005 (black) body and side panels of all cabinets | | | | | | | | |
| UPS dimensions WxDxH (mm)* | 2770x970x2100 | 4090x970x2100 | 4970x980x2100 | 5370x980x2100 | 6250x980x2100 | 7580x1200x2100 | 8460x1200x2100 | | |
| UPS weight (kg)* | 2250 | 3150 | 3300 | 4000 | 4250 | 4900 | 5200 | 6400 | 7300 |
| Ambient conditions | | | | | | | | | |
| Operating temperature (°C) | 0 - 40 °C (recommended temperature for longer useful battery life: 20-25°C) | | | | | | | | |
| Relative humidity (%) | 20-95% (non condensing) | | | | | | | | |
| Protection rating | IP20 (IP21 Optional) | | | | | | | | |
| Noise at 1 m from the unit (dBA) | < 65 | | | | | | | | |
| Estimated content of circular economy derived materials | ≈ 20% | | | | | | | | |
| Recyclability rate calculated using the method described in technical report IEC/TR 62635* | ≈ 60% | | | | | | | | |
| Conformity | | | | | | | | | |
| Certifications | IEC/EN 62040-1, IEC/EN 62040-2, IEC/EN 62040-3 | | | | | | | | |

* Weights and dimensions depend on the configuration chosen and refer to the complete basic system (no redundancy, no hot swapping).

**This value is based on data collected from a technological channel operating on an industrial basis. It does not pre-validate the effective use of this channel for end-of-life of this product.



BATTERY CABINET

For all three-phase UPS.



Battery cabinet

For all three-phase UPS



3 106 57 up to 20 batteries 105 Ah



3 109 82 up to 62 batteries 105 Ah

Universal battery cabinets for all three-phase Legrand UPS from 10kVA up to 800kVA power range. The Battery cabinet is designed to house standard VRLA Batteries of capacity range from 24Ah to 105Ah (C10). The battery cabinets are available in 5 different mechanical dimensions, are able to contain various combination of Batteries, up to maximum 63 blocks, connected in series and parallel, with positive, negative and middle point poles and with max DC voltage of 800Vdc.

| Item | Empty battery cabinet* | | | | UPS Compatibility |
|-----------------|-------------------------|-----------------|----------------------------------|------------------------|---------------------|
| | Cabinet Dimensions (mm) | TOT Weight (kg) | Indicative Battery Capacity (Ah) | Standard No. Of Blocks | |
| 3 106 26 | 800x900x1420 | 213 | 24 | 60 | Keor T |
| 3 106 27 | 800x900x1420 | 214 | 24 | 40 | Trimod HE |
| 3 106 55 | 800x900x1420 | 213 | 55 | 20 | Trimod HE |
| 3 106 56 | 800x900x1420 | 215 | 70-93 | 20 | Trimod HE |
| 3 106 57 | 800x900x1420 | 215 | 105 | 20 | Trimod HE |
| 3 106 58 | 800x900x1900 | 253 | 24 | 21 | Archimod HE |
| 3 106 59 | 800x900x1900 | 253 | 24 | 60-62 | Keor HPE |
| 3 106 70 | 800x900x1900 | 254 | 24 | 42 | Archimod HE |
| 3 106 71 | 800x900x1900 | 253 | 24 | 63 | Archimod HE |
| 3 106 72 | 800x900x1900 | 253 | 41 | 21 | Archimod HE |
| 3 106 73 | 800x900x1900 | 253 | 41 | 60-62 | Keor HPE / Keor T |
| 3 106 74 | 800x900x1900 | 254 | 41 | 42 | Archimod HE |
| 3 109 40 | 800x900x1900 | 253 | 55 | 21 | Archimod HE |
| 3 109 41 | 800x900x1900 | 254 | 55 | 42 | Archimod/Trimod HE |
| 3 109 42 | 800x900x1900 | 255 | 70-93 | 21 | Archimod HE |
| 3 109 43 | 800x900x1900 | 255 | 105 | 21 | Archimod HE |
| 3 109 44 | 1200x900x1900 | 333 | 55 | 60-62 | Keor HPE / Keor T |
| 3 109 65 | 1200x900x1900 | 335 | 70-93 | 50-52 | Keor HP |
| 3 109 66 | 1200x900x1900 | 336 | 70-93 | 40-42 | Archimod/Trimod HE |
| 3 109 67 | 1200x900x1900 | 335 | 105 | 50-52 | Keor HP |
| 3 109 68 | 1200x900x1900 | 336 | 105 | 42 | Archimod/Trimod HE |
| 3 109 80 | 1400x900x1900 | 385 | 70-93 | 60-62 | Keor HPE / Keor T |
| 3 109 81 | 1400x900x1900 | 385 | 70-93 | 60 | Trimod HE |
| 3 109 82 | 1400x900x1900 | 385 | 105 | 60-62 | Keor HPE / Keor T |
| 3 109 83 | 1400x900x1900 | 385 | 105 | 60 | Trimod HE |
| 3 109 84 | 1400x900x2080 | 415 | 105 | 21 | Archimod HE 240/480 |
| 3 109 85 | 1400x900x2080 | 416 | 105 | 42 | Archimod HE 240/480 |
| 3 109 86 | 1400x900x2080 | 415 | 105 | 63 | Archimod HE 240/480 |

* in the cabinet are included Fuse Holder Switch and Fuses. Batteries not included

Characteristics

| General characteristics | |
|--|---|
| Nominal Voltage | 800 Vdc |
| Battery segregation | Internal panel in Polycarbonate |
| Switches and protection access | Internal bottom front side |
| Disconnection and protection devices * | Fuse Holders Switch with NH fast fuses (sized accordingly with Battery Power) |
| Fuse holder Open/Close signal* | Auxiliary Micro Switch |
| Cable Entrance | bottom sides (both left and right) |
| Cable connections | On Fuse holder terminals |
| Max Cable side entrance | 3x 150mm ² |
| Cabinet Access | Front door with key lock and removable sides and rear panels |
| Shelter Bent Metal Sheet Thickness | 20/10 |
| Shelves Bent Metal Sheet Thickness | 30/10 |
| Protection Degrees | IP20 (Optional IP21) |
| Colour | RAL 7016 |
| Standard | IEC-EN 62040-1 |



COMMUNICATION ACCESSORIES AND SOFTWARE

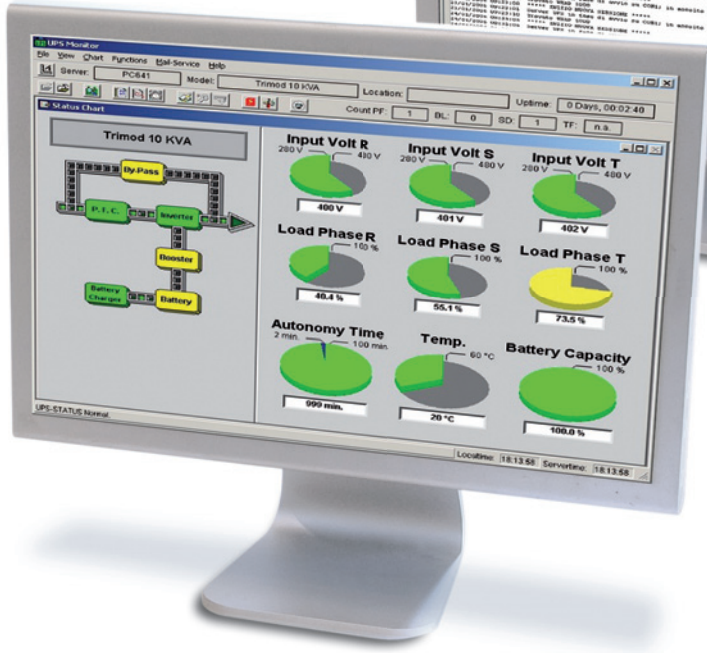
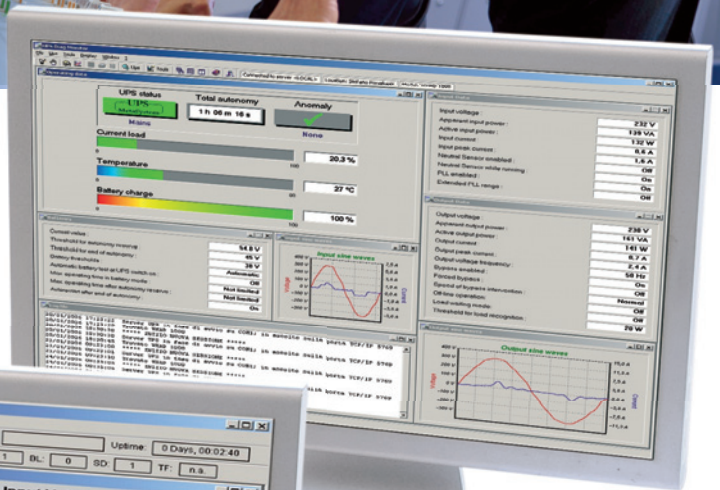

Accessories

network interfaces



| Model | Item | Network interface CS141 |
|-----------|-----------------|---|
| | | <p>Network interfaces for UPS management do not require external software; in fact, they are equipped with their own proprietary operating system which is able to continuously control the UPS operations and handle multiple events (power failure, overload, bypass, anomaly, etc.) and consequently to carry out a series of actions, such as, for instance:</p> <ul style="list-style-type: none"> - Saving of event logs complete with date and time - Saving of main operating data trends complete with date and time - Sending of emails - Performance of scheduled actions - Display of pop-up messages, shutdown operations and custom commands on remote computers (it is necessary that the RCCMD software agent is installed on these computers) - Switching ON and OFF the UPS - Sending of "Wake on LAN (WOL) " signals - SNMP protocol support - Sending of SNMP trap messages - Data display and configuration via internet browser - Firmware downloadable free of charge from the Internet - 10/100Mbit Base-T Ethernet connection (half-duplex and full-duplex) with self-recognition function - DHCP function - No. 1 RCCMD license included <p>Available in both internal and external versions, the internal version is housed in a dedicated UPS slot. The professional versions have an additional RS232 communication port. The industrial versions have an additional RS485 communication port.</p> |
| CS141 SK | 3 109 30 | Professional network interface internal version (slot) |
| CS141B SK | 3 109 31 | Standard network interface internal version (slot) |
| CS141 | 3 109 32 | Professional network interface external version |
| CS141B | 3 109 33 | Standard network interface external version |
| CS141M | 3 109 34 | Industrial network interface external version |
| CS141M SK | 3 109 35 | Industrial network interface internal version (slot) |
| | | Network interface CS101 |
| CS101 | 3 109 38 | Network interface internal version (slot) compatible with Daker DK, Daker DK Plus, Keor S, Keor LP, Keor Line RT, Keor T, Keor T Evo |

CS141 Characteristics

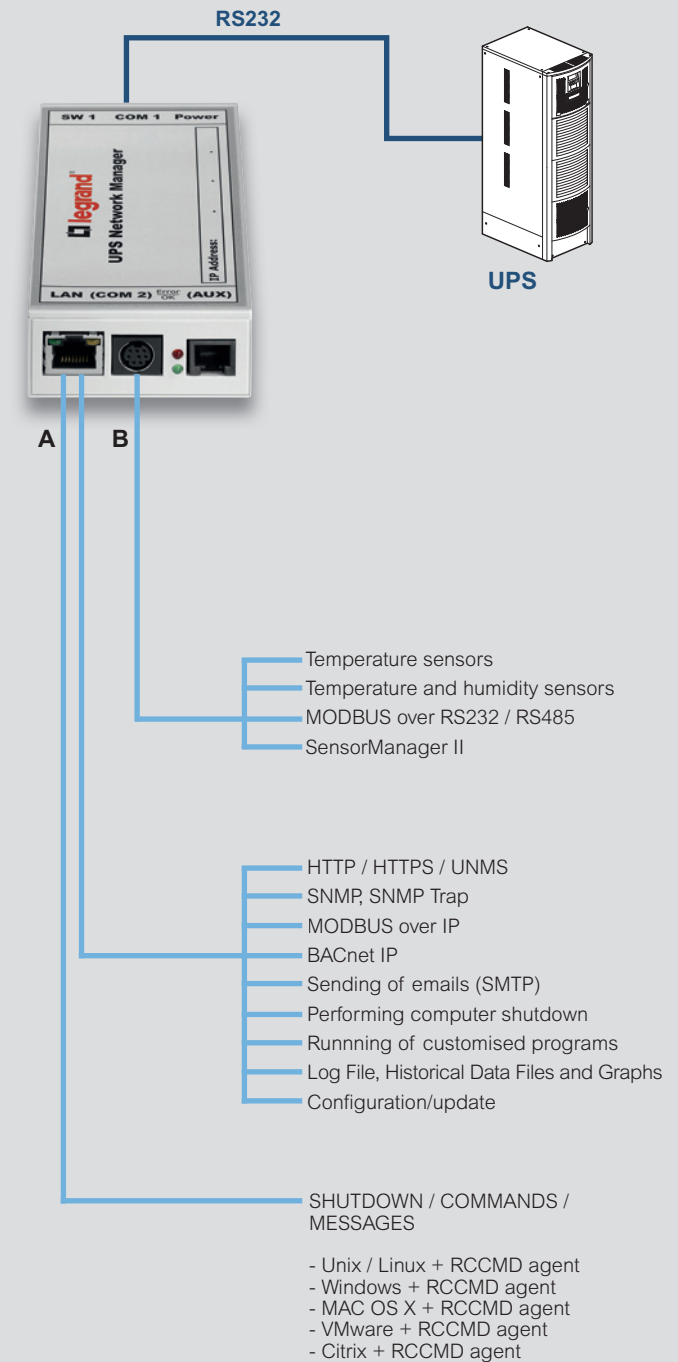

| Model | A | B |
|-----------|---|----|
| CS141B | X | |
| CS141B SK | X | |
| CS141 | X | X |
| CS141 SK | X | X |
| CS141M | X | X* |
| CS141M SK | X | X* |

*modbus over RS485 only.

Accessories

sensors and various accessories



| Model | Item | Sensors |
|------------------|-----------------|--|
| SM_T_COM | 3 108 97 | Temperature sensor for direct connection to the COM2 of the CS141, CS141 SK interfaces. Cannot be used with SensorManager II. |
| SM_T_H_COM | 3 108 98 | Combined temperature and humidity sensor for direct connection to the COM2 of the CS141, CS141 SK interfaces. Cannot be used with SensorManager II. |
| SensorManager II | 3 108 99 | Ambient sensor manager: it connects to the COM2 of the CS141, CS141 SK interfaces and manages up to 8 analogue inputs, 4 digital inputs and 4 digital outputs. The configuration is managed directly by the CS141 interfaces (PROFESSIONAL versions) described above. The "Scale Divisor" and "offset" configuration functions allow the SensorManager II to be used with any analogue device (see characteristics). No. 1 "SM_T" temperature sensor included. |
| SM_T | 3 109 00 | Temperature sensor for exclusive use with SensorManager II. It allows the connection of another "SM_T" sensor via a designated connector. |
| SM_T_H | 3 109 01 | Combined temperature and humidity sensor for exclusive use with SensorManager II. |
| Port sensor | 3 109 02 | It consists of a reed switch and a magnet. Compatible exclusively with SensorManager II. |
| SM_flash | 3 109 03 | Flashing light signal. Compatible exclusively with SensorManager II. |

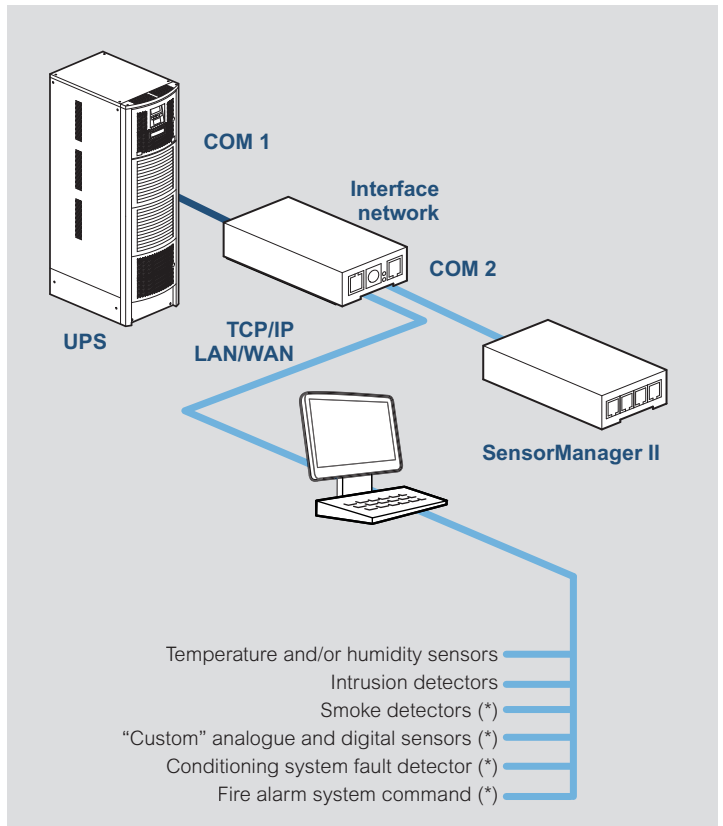

(*) Not supplied by Legrand

■ SensorManager II technical characteristics

| | |
|----------------------------|---------------|
| Power supply voltage (VDC) | 9-24 |
| Temperature (°C) | 0 - 65 |
| non condensing humidity % | 10 - 80 |
| Analogue inputs (V) | 0 ÷ 10 |
| Digital inputs V (20 mA) | 9 ÷ 24 |
| Digital outputs V (100mA) | 9 ÷ 24 |
| Dimensions (HxWxD) (mm) | 70 X 130 X 30 |

■ Sensor technical characteristics

| | 3 108 97 | 3 108 98 | 3 109 00 | 3 109 01 |
|-------------------------------|--------------|----------|----------|----------|
| Range of temperature (°C) | -25÷+100 | -25÷+100 | 0 ÷ +100 | 0 ÷ +100 |
| Humidity Relative % (+- 5%) | | 0 ÷ 100 | | 0 ÷ 100 |
| Connection cable m (included) | 1.8 | 1.8 | 5 | 5 |
| Dimensions HxWxD (mm) | 27 X 70 X 70 | | | |

Accessories

management software

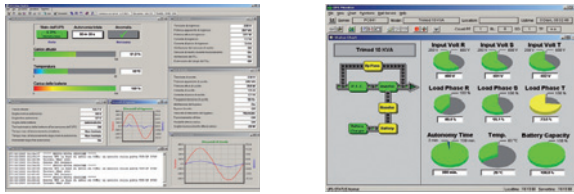

| Model | Item | Software |
|-------------------------|--------------|--|
| | | Description |
| UPS Communicator | downloadable | Software consisting of a set of applications designed to continuously monitor the UPS unit operations and guarantee the integrity of the operating systems of the computers powered by the same UPS unit. Complete with agent for executing commands on remote computers (RS System). |
| UPS Management Software | 3 108 79 | Software consisting of a set of applications designed to continuously monitor the UPS unit operations and guarantee the integrity of the operating systems of the computers powered by the same UPS unit. To be completed with agent for executing commands on remote computers (RCCMD). 1 RCCMD licence included. |
| UPS Management Software | 3 108 80 | Software consisting of a set of applications designed to continuously monitor the UPS unit operations and guarantee the integrity of the operating systems of the computers powered by the same UPS unit. RS232/USB converter included. To be completed with agent for executing commands on remote computers (RCCMD). 1 RCCMD licence included. |
| RCCMD | | Software that enables a computer to receive and execute, by means of a TCP/IP protocol, all remote commands transmitted by the UPS Management Software and any CS141 network interface. An RCCMD licence is required for each controlled computer. Only the licences are supplied: the software is downloadable from the Internet. |
| RCCMD | 3 108 85 | Multi OS RCCMD licence |
| RCCMD | 3 108 86 | Pack of 5 multi OS RCCMD licenses |
| RCCMD | 3 108 87 | Pack of 10 multi OS RCCMD licenses |
| RCCMD | 3 108 88 | Pack of 25 multi OS RCCMD licenses |
| RCCMD | 3 108 89 | Pack of 50 multi OS RCCMD licenses |
| RCCMD | 3 108 90 | RCCMD licence for AS/400 (minimum release: V5R3M0) |
| UNMS | | A "WEB based" application which is able to continuously monitor the status of all UPS units via the UPS management systems and TCP/IP protocol. |
| UNMS | 3 108 91 | UNMS licence for 25 UPS |
| UNMS | 3 108 92 | UNMS licence for 50 UPS |
| UNMS | 3 108 93 | UNMS licence for 150 UPS |

Examples of the types of management and communication that can be created using the software and hardware

Local protection

Protects one station only (PC or server) and must be installed at a distance of less than 12 metres (RS232) or 5 metres (USB).

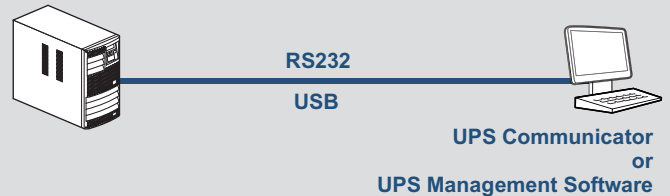

Extended local protection

Protects multiple stations (PC or server) but all must be dependent on the COMPUTER that controls the UPS.

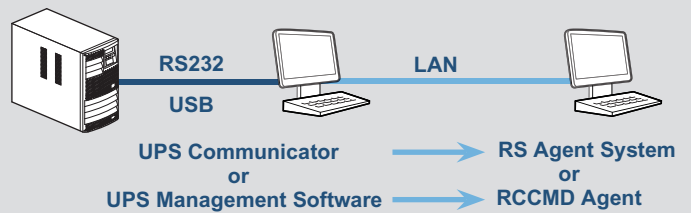

Extended local protection

Enables control of all the stations that can be managed by the UPS network interface. The coordination of the entire system can be monitored and controlled by each authorised user.

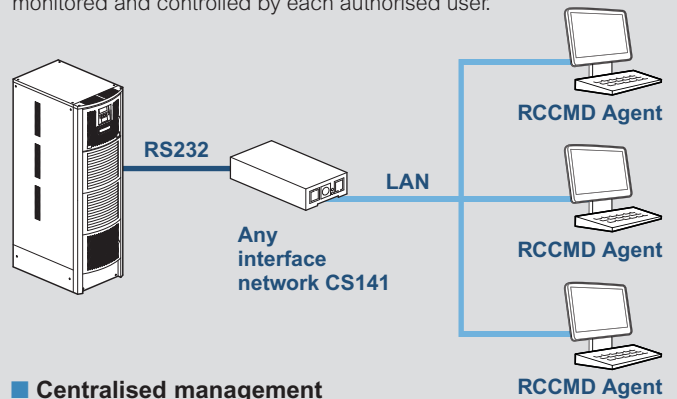

Centralised management

Using the UNMS supervision software, it is possible to control all the UPS connected to a TCP/IP network via any network interface that supports SNMP v1 or v2 protocols.

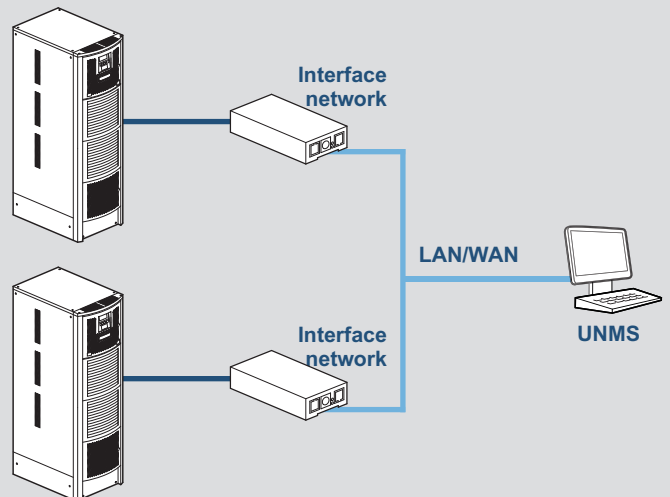

Download the free UPS management software at www.ups.legrand.com

Communication accessories compatibility table

| | UPS Communicator | UPS Management Software | | CS141 SK | CS141B SK | CS141 | CS141B | CS141M | CS141M SK | CS101 |
|--------------------------|------------------|-------------------------|----------|----------|-----------|----------|----------|----------|-----------|----------|
| | Free | 3 108 79 | 3 108 80 | 3 109 30 | 3 109 31 | 3 109 32 | 3 109 33 | 3 109 34 | 3 109 35 | 3 109 38 |
| UPS | | | | | | | | | | |
| Keor PDU | ✓ | ✓ | | | | | | | | |
| Keor SP | ✓ | ✓ | | | | | | | | |
| Niky S | ✓ | ✓ | | | | ✓ | ✓ | ✓ | | |
| Daker DK Plus | ✓ | ✓ | | ✓ | ✓ | | | | ✓ | ✓ |
| Keor Line RT | ✓ | ✓ | | ✓ | ✓ | | | | ✓ | ✓ |
| Keor LP | ✓ | ✓ | | ✓ | ✓ | | | | ✓ | ✓ |
| Keor S 3000 | ✓ | ✓ | | ✓ | ✓ | | | | ✓ | ✓ |
| Keor S 6000 - 10000 | ✓ | ✓ | ✓ | ✓ | ✓ | | | | ✓ | ✓ |
| Megaline / Megaline Rack | ✓ | ✓ | ✓ | | | ✓ | ✓ | ✓ | | |
| Keor T Evo | | ✓ | ✓ | ✓ | ✓ | | | | ✓ | ✓ |
| Keor HP | | ✓ | ✓ | ✓ | ✓ | | | | ✓ | |
| Keor HPE | | ✓ | ✓ | ✓ | ✓ | | | | ✓ | |
| Trimod HE | ✓ | ✓ | ✓ | ✓ | ✓ | | | | ✓ | |
| Keor MOD | | | | ✓ | ✓ | | | | ✓ | |
| Keor Compact | | ✓ | ✓ | ✓ | ✓ | | | | ✓ | |
| Keor XPE | | ✓ | ✓ | ✓ | ✓ | | | | ✓ | |
| Software | | | | | | | | | | |
| RCCMD (all codes) | | ✓ | ✓ | ✓ | ✓ | ✓ | ✓ | ✓ | ✓ | |
| UNMS (all codes) | | | | ✓ | ✓ | ✓ | ✓ | ✓ | ✓ | ✓ |

Other accessories

| | SM_T_COM | SM_T_H_COM | Sensor Manager | SM_T | SM_T_H | Port sensor | SM_Flash |
|---------------------------|----------|------------|----------------|----------|----------|-------------|----------|
| | 3 108 97 | 3 108 98 | 3 108 99 | 3 109 00 | 3 109 01 | 3 109 02 | 3 109 03 |
| 3 109 30 - CS141 SK | ✓* | ✓* | ✓* | | | | |
| 3 109 32 - CS141 | ✓* | ✓* | ✓* | | | | |
| 3 108 99 – Sensor Manager | | | | ✓ | ✓ | ✓ | ✓ |

* Not for simultaneous use

CUSTOMER SERVICES



Reliable

Directly present in more than 70 countries and servicing its products in more than 150 countries worldwide, a team of qualified engineers is available to support your UPS system to ensure power quality and availability to the most critical loads.

Excellent

Legrand's competitive edge lies in its ability to provide high value-added UPS systems and services for both end users and business partners.

For Legrand, creating value means coming up with solutions for lower energy consumption, but also integrating product design into the overall development process. With around 200 000 catalogue items, the Group also provides all products required for electrical and digital building installations, particularly as integrated systems, finding solutions to fit everyone's needs.

Tailor-made

Legrand offers a complete range of specific solutions and services to meet customer requirements:

- Technical pre-sales support at the project design stage
- Factory acceptance test
- Supervision of installation, testing and commissioning, site acceptance test
- Operator training
- Site audit
- Warranty extension
- Annual maintenance contract
- Fast intervention on emergency call

CUSTOMER SERVICES

SUPPORT



SITE INSPECTION, INSTALLATION SUPERVISION.

We perform a comprehensive check of the UPS environment to ensure safety and fault-free operation. Our technical experts give manufacturer's recommendations to the site engineer or electrical contractors, and supervise the UPS installation before load power-up.

SITE TEST, COMMISSIONING.

Our Service Engineers conduct rigorous site tests and full setting-up of the UPS system before going live. They also perform site acceptance tests according to your requirements. Commissioning operations for all UPS are carried out by qualified engineers to guarantee seamless start-up. After the final handing over of the UPS system, a Test and Commissioning report is delivered to you.

TRAINING



We offer on-site training to ensure your equipment's safe and efficient operation.

Troubleshooting courses are also available in our plants for intensive hands-on practice on UPS training equipment.

MAINTENANCE



PREVENTIVE MAINTENANCE

Electronic equipment and power systems, such as UPS, contain life-limited components and parts that must be replaced according to the manufacturer's specifications. To ensure optimal performance and to protect your critical application from potential downtime, it is crucial to perform

preventive maintenance operations on a regular basis and replace parts when needed. Our Service Contracts include cleaning, IR thermography, measurements, functional tests, event log and power quality analysis, battery health check, hardware and software upgrades, and technical reports. A Preventive Maintenance Plan is one of the most cost-effective actions that can preserve your initial investment and ensure your business continuity.

CORRECTIVE MAINTENANCE, EMERGENCY CALL

In the event of an Emergency Call, our worldwide service network, with engineers and spare-parts stocks strategically located as close as possible to your site, guarantees a fast intervention time with 24/7/365 assistance. After connecting his laptop to your UPS, very powerful diagnostic software helps our engineer to identify the fault, thus ensuring short MTTR (Mean Time To Repair). Corrective actions are performed such as part replacement, adjustments and upgrades to return the UPS system back to normal operation.



FOLLOW US
ALSO ON

@ www.ups.legrand.com



**World Headquarters and
International Department**
87045 Limoges Cedex - France
☎ : + 33 (0) 5 55 06 87 87
Fax : + 33 (0) 5 55 06 74 55